

Flat duct



Application

- Supply and exhaust ventilation of various premises.
- Formation of flat air ductworks.

Design

- Made of white PVC.
- Size: 55x110, 60x122, 60x204 mm.
- Duct length from 350 to 2500 mm.
- Connected with matching connectors.

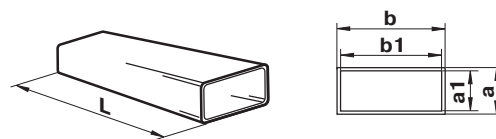

Code	Dimensions [mm]				
	a	b	a1	b1	L
50035	55	110	52	107	350
70035	60	122	57	119	350
80035	60	204	57	200	350
5005	55	110	52	107	500
7005	60	122	57	119	500
8005	60	204	57	200	500
5010	55	110	52	107	1000
7010	60	122	57	119	1000
8010	60	204	57	200	1000

Code	Dimensions [mm]				
	a	b	a1	b1	L
5015	55	110	52	107	1500
7015	60	122	57	119	1500
8015	60	204	57	200	1500
5020	55	110	52	107	2000
7020	60	122	57	119	2000
8020	60	204	57	200	2000
5025	55	110	52	107	2500
7025	60	122	57	119	2500
8025	60	204	57	200	2500

Flat duct connector



Application

- Supply and exhaust ventilation of various premises.
- Connection of same sized flat ducts.

Design

- Made of white plastic.
- Designed for installation into air duct and equipped with a lock ring for easy jointing.
- Connecting sizes: 55x100, 60x122, 60x204 mm.

Code	Dimensions [mm]				
	a	b	a1	b1	c
515	55	110	59	114	66
717	60	122	63	125	69
818	60	204	64	208	91

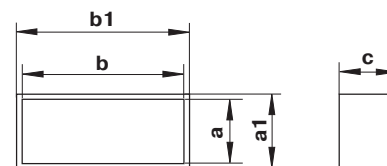

Flat duct connector with damper



Application

- Supply and exhaust ventilation of various premises.
- Connection of same sized flat ducts.

Design

- Made of white plastic.
- Designed for installation into air duct and equipped with a lock ring for easy jointing.
- Equipped with a backdraft damper for back flow prevention.
- Connecting sizes: 55x100, 60x122, 60x204 mm.

Code	Dimensions [mm]				
	a	b	a1	b1	c
5151	55	110	59	114	66
7171	60	122	63	125	70
8181	60	204	64	208	91

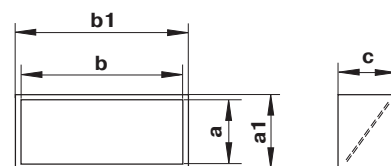

Flexible flat duct connector



Application

- Supply and exhaust ventilation of various premises.
- Connection of same sized flat flexible ducts.

Design

- Made of white PVC.
- Cover the connector with air duct and fix it with clamps.
- Connecting sizes: 55x100, 60x122, 60x204 mm.

Code	Dimensions [mm]				
	a	b	a1	b1	c
5153	55	110	52	107	60
7173	60	122	57	119	60
8183	60	204	57	200	60

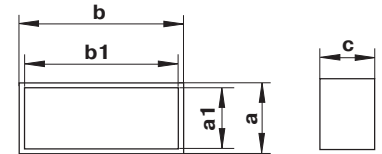

Air duct connector with a plate



Application

- Supply or exhaust ventilation of various premises.
- Connection of single size flat air ducts.
- Decoration of mounting opening and connections to wall.

Design

- Made of white plastic.
- Air ducts are fitted inside the connector.
- Equipped with lock rings for easy adjustment.
- Screw fixing to wall.
- Connecting sizes: 55x110, 60x120, 60x204 mm.

Code	Dimensions [mm]							
	a	b	c	A	B	C	D	L
555	110	55	2	141	154	154	141	131
757	120	60	2	141	154	154	141	131
858	204	60	3	229	154	242	141	186

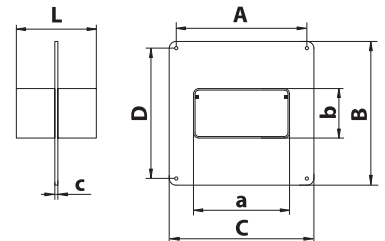

Air duct connector with a plate and a back valve



Application

- Supply or exhaust ventilation of various premises.
- Connection of single size flat air ducts.
- Decoration of mounting opening and connections to wall.

Design

- Made of white plastic.
- Air ducts are fitted inside the connector.
- Equipped with lock rings for easy adjustment.
- Equipped with a back valve to prevent back drafting.
- Screw fixing to wall.
- Connecting sizes: 55x110, 60x120, 60x204 mm.

Code	Dimensions [mm]							
	a	b	c	A	B	C	D	L
5551	110	55	2	141	154	154	141	131
7571	120	60	2	141	154	154	141	131
8581	204	60	3	229	154	242	141	186

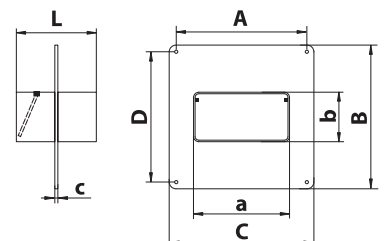

Vertical 90° bend for flat ducts



Application

- Supply and exhaust ventilation of various premises.
- Connection of same sized flat ducts at 90° vertically.

Design

- Made of white plastic.
- Connecting sizes: 55x100, 60x122, 60x204 mm.

Code	Dimensions [mm]		
	a	b	c
5252	55x110	89	32
7272	60x120	93	32
8282	60x204	103	42

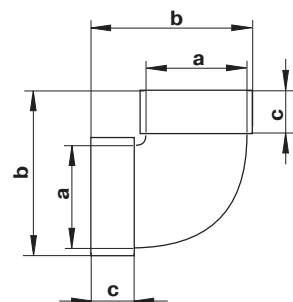

Horizontal 90° bend for flat ducts



Application

- Supply and exhaust ventilation of various premises.
- Connection of same sized flat ducts at 90° horizontally.

Design

- Made of white plastic.
- Connecting sizes: 55x100, 60x122, 60x204 mm.

Code	Dimensions [mm]		
	a	b	c
5251	55x110	143	32
7271	60x122	155	32
8281	60x204	238	32

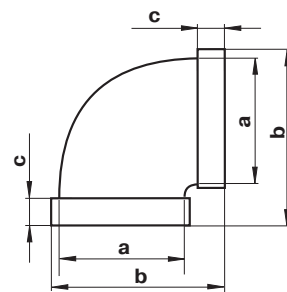

Versatile flat angular connector



Application

- Supply and exhaust ventilation of various premises.
- Angular connection of flat ducts.

Design

- Made of white plastic.
- Turning point angle from 3° to 48°.
- Depending on selected turning angle one connector side is cut out. Connection to the flat duct through matching sized connector.
- On flange side direct connection to flat duct of respective size.
- Connecting section: 55x100 and 60x204 mm.

Code	Dimensions [mm]		
	a	b	c
52510	190	143	55x110
82810	286	247	60x204

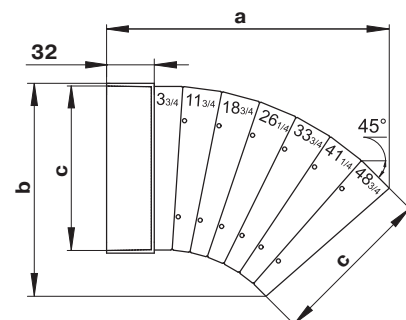

T-joint for flat ducts



Application

- Formation of branch connections in supply or exhaust ventilation systems located in residential, public and other buildings.
- Connection of same sized flat ducts and integration into complex ventilation systems.

Design

- Made of white plastic.
- Connection of same sized three flat ducts at 90°.
- Connecting sizes: 55x100, 60x122, 60x204 mm.
- Direct connection to matching sized ducts.

Code	Dimensions [mm]		
	a	b	c
535	144	174	55x110
737	155	185	60x122
838	248	288	60x204

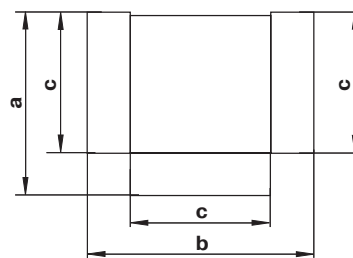

Flat duct holder



Application

- Supply and exhaust ventilation of various premises.
- Mounting of flat ducts to wall, ceiling or any other plane surface.

Design

- Made of white plastic.
- Fixation to plane surface with screws.
- Specially designed configuration provides reliable duct to holder fixation and quick dismantling.
- Connecting sizes: 55x100, 60x122, 60x204 mm.

Code	Dimensions [mm]		
	a	b	c
56	114	59	74
76	126	64	86
86	209	65	169

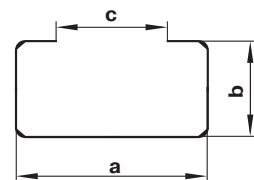

90° connecting bend for flat and round ducts



Application

- Supply and exhaust ventilation of various premises.
- Connection of flat and round ducts at 90°.

Design

- Made of white plastic.
- Connecting dimensions: 55x110-100, 60x122-100, 60x204-100, 60x204-125, 60x204-150mm.
- Flat ducts have direct connection and round ducts are connected through a matching connector.

Code	Dimensions [mm]					
	a	D	D1	b	h	L
521	55x110	100	103	58x113	87	138
721	60x122	100	103	63x125	87	140
821	60x204	97	100	64x208	92	140
822	60x204	122	125	64x208	92	164
823	60x204	147	150	64x208	92	188

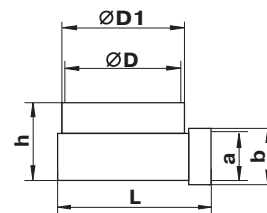

T-joint for flat and round ducts



Application

- Formation of branch connections in supply or exhaust ventilation systems located in residential, public and other buildings.
- Connection of flat and round ducts.

Design

- Made of white plastic.
- Connecting dimensions: 55x110-100 mm.
- Direct connection to air duct.

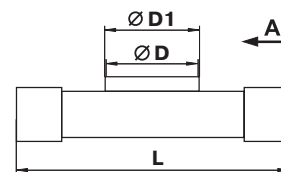

Code	Dimensions [mm]						
	axb	D	D1	c	d	h	L
531	55x110	100	103	58	113	87	172

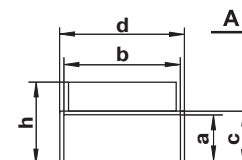

Reducer for flat ducts



Application

- Supply and exhaust ventilation of various premises.
- Connection of flat different sized ducts.

Design

- Made of white plastic.
- Connecting dimensions: 55x110-60x204 mm.

Code	Dimensions [mm]		
	b	a	c
518	60x204	55x110	30

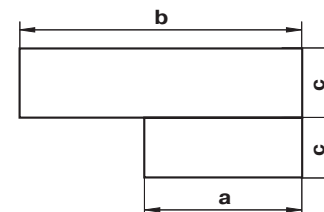

Wall plate for flat ducts



Application

- Supply and exhaust ventilation of various premises.
- Connection of air ducts to ventilation shafts.
- Decoration of mounting openings.

Design

- Made of white plastic.
- Screw fixing to wall.
- Connecting sizes: 55x100, 60x122, 60x204 mm.

Code	Dimensions [mm]						
	a	b	c	d	e	D	E
55	111	56	2	141	141	154	154
75	123	61	2	141	141	154	154
85	205	61	3	229	141	242	154

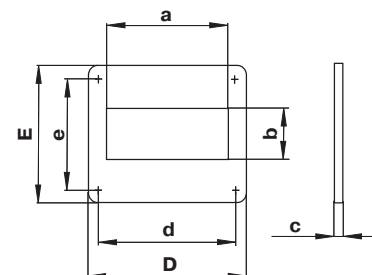

End grille



Application

- Decoration of supply or exhaust vents of public, residential and industrial ventilation systems.
- Correct air flow distribution in premises.
- Wall or ceiling mounting.

Design

- Made of white plastic.
- Detachable front part facilitates cleaning.
- Modification with an insect screen (s) is available.
- Connecting dimensions: 55x110 and 60x204 mm.

Code	Dimensions [mm]					
	a	b	c	d	e	f
571	88	137	114	59	73	9
871	93	232	208	64	76	9

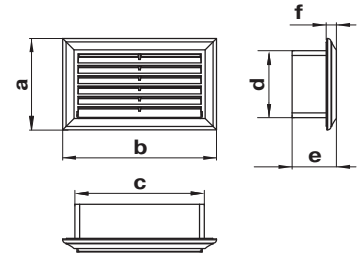

End grille with air pass regulation



Application

- Decoration of supply or exhaust vents of public, residential and industrial ventilation systems.
- Correct air flow distribution in premises.
- Wall or ceiling mounting.

Design

- Made of white plastic.
- Equipped with a movable flap for air capacity regulation.
- Air pass is regulated with a tilt wand.
- Detachable front part facilitates cleaning.
- Modification with an insect screen (s) is available.
- Matches with 55x110 and 60x204 mm air ducts.

Code	Dimensions [mm]					
	a	b	c	d	e	f
572	88	137	114	59	73	18
872	93	232	208	64	76	18

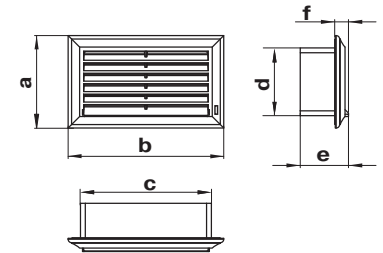

Reducer for flat and round ducts



Application

- Supply and exhaust ventilation of various premises.
- Flat to round duct connection.

Design

- Made of white plastic.
- Connecting dimensions: 55x110-100 mm.
- Direct connection of reducer to round and flat ducts.

Code	Dimensions [mm]			
	cx b	Ø D	f	a
115	58x114	103	62	32

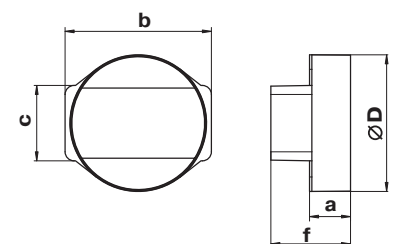

Reducer for flat and round ducts



Application

- Supply and exhaust ventilation of various premises.
- Flat to round duct connection.

Design

- Made of white plastic.
- Connecting dimensions: 55x110-100 mm.
- Reducer has direct connection to flat air ducts and connection through connector to round ducts

Code	Dimensions [mm]			
	cxb	∅ D	f	a
1156	58x114	100	62	32

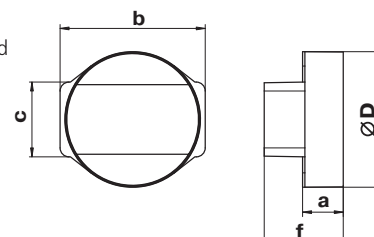

Wall plate with flange



Application

- Supply and exhaust ventilation of various premises.
- Connection of air ducts to ventilation shafts.
- Decoration of mounting openings.

Design

- Made of white plastic.
- Screw fixing to wall.
- Connecting sizes: 60x122 mm.

Code	Dimensions [mm]						
	a	b	c	d	D	e	E
750	126	172	3	65	113	60	65

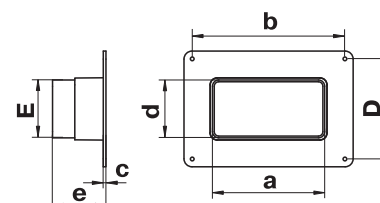

Round to flat connector (symmetric)



Application

- Supply and exhaust ventilation of various premises.
- Connection of round and flat ducts.

Design

- Made of white plastic.
- Direct connection flat duct, connection to round duct with connector.
- Connecting ducts: 100-60x122 mm.

Code	Dimensions [mm]							
	a	b	c	∅ D	∅ D1	e	h	L
7112	124	122	30	100	103	60	64	137

