

USER MANUAL

Air handling unit with heat recovery

VUT 300 EVK mini EC
VUT 300 EV mini EC
VUT 301 EVK mini EC
VUT 301 EV mini EC



CONTENTS

Introduction	3
Use	3
Delivery set	3
Structural designation key	4
Technical data	4
Safety requirements	6
Structure and operating logic	7
Mounting and set-up	8
Condensate drainage	10
Connection to power mains	11
Unit control	12
Maintenance	19
Fault handling	22
Storage and transportation rules	23
Manufacturer's warranty	23
Acceptance certificate	24
Electrical connection certificate	24
Warranty card	24



INTRODUCTION

The present user manual consisting of technical details, operating instructions and technical specification covers the installation of the VUT 300 (301) EV (K) mini EC air handling unit with heat recovery, VENTS series (hereinafter the unit).

USE

The unit is designed to save thermal energy by means of heat recovery and is one of the energy saving components used in buildings and premises.

The air handling unit is a component unit and is not designed for independent operation.

The unit is designed to provide permanent controllable air exchange by mechanical ventilation in houses, offices, hotels, cafés, meeting halls and other mechanically ventilated premises as well as utilization of extract air heat energy to warm up supply purified air.

Transported medium must not contain any flammable or explosive mixtures, evaporation of chemicals, coarse dust, soot and oil particles, sticky substances, fibrous materials, pathogens or any other harmful substances.



Warning!

The unit is not allowed for operation without properly installed fat filters or with the clogged fat filters because ingress of oil and sticky substances may damage the unit.



The unit is not designed to be used by children, physically or mentally disabled persons, persons with sensory disorder or with no appropriate experience or expertise. The unit must be handled only by properly qualified personnel after the appropriate safety briefing. Install the unit to be out of reach of children.

DELIVERY SET

- | | |
|---------------------|-----------|
| ■ Unit | - 1 item; |
| ■ User's manual | - 1 item; |
| ■ Remote controller | - 1 item; |
| ■ Shipping box | - 1 item; |
| ■ Fastener kit | - 1 item. |

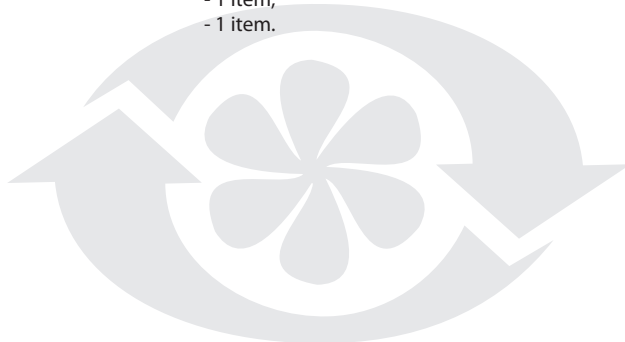

STRUCTURAL DESIGNATION KEY

VUT 300 EVK mini EC

Motor type electronically commutated
Modification K - kitchen hood
Spigot orientation V - vertical
Electric heater
Air capacity, m³/h 300 - unit with an integrated control panel; 301 - unit with a remote control panel.
Unit type VUT - heat recovery ventilation

TECHNICAL DATA

The unit is designed for operation in an enclosed area at ambient temperatures from +1 °C to +40 °C at relative humidity of up to 80%.

The unit must be grounded!

Hazardous parts access and water ingress protection standard:

- Unit motors - IP 44;
- Unit assembly connected to air ducts - IP 22.

The unit series designations, their main outside and connecting dimensions, appearance and technical data are given in figures 1, 2 and in Tables 1 and 2.

The unit design is regularly being improved, so some models can slightly differ from those ones described in this manual.



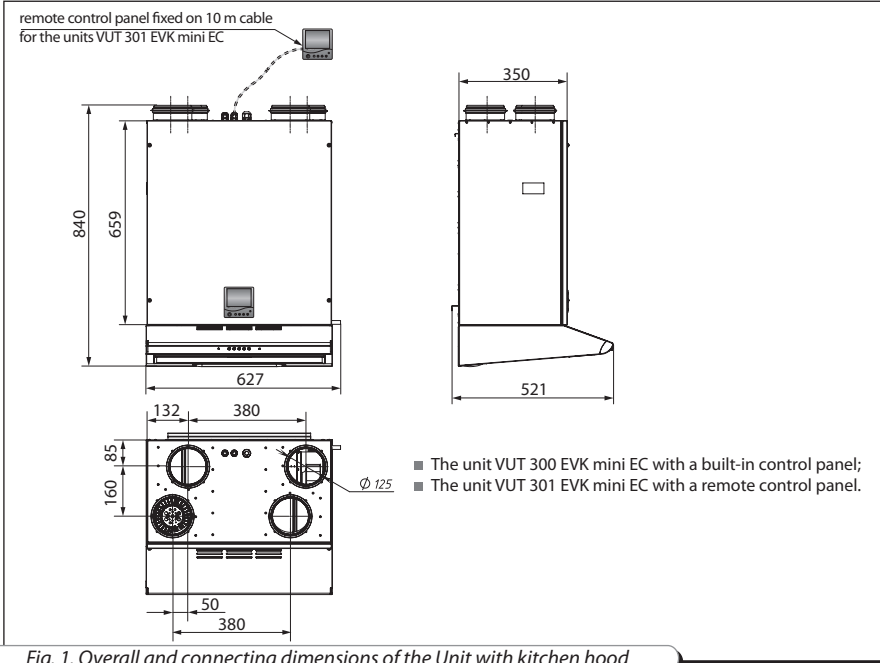

Fig. 1. Overall and connecting dimensions of the Unit with kitchen hood

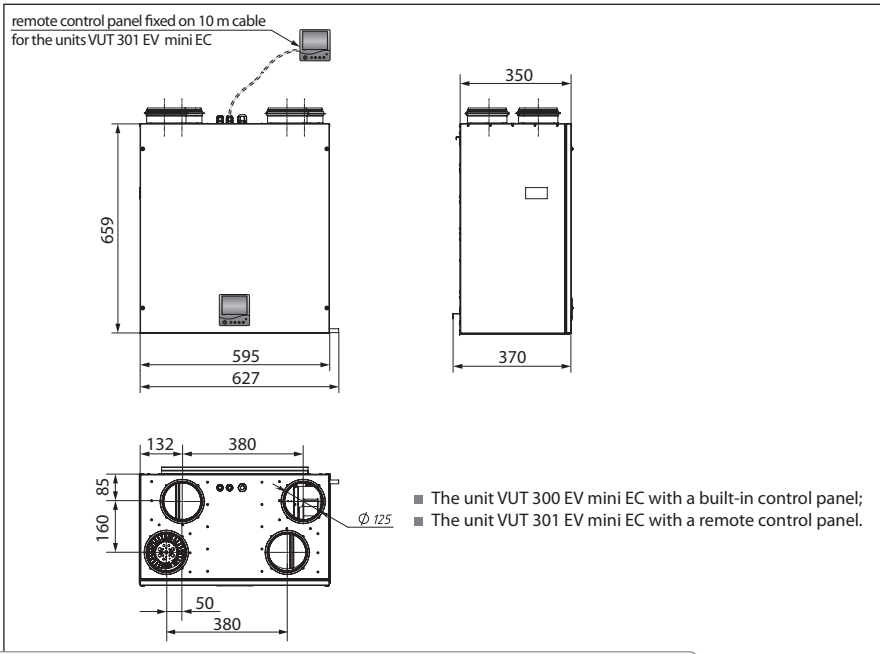

Fig. 2. Overall and connecting dimensions of the unit without kitchen hood

Table 1. Technical parameters of the unit

Model	VUT 300 (301) EV(K) mini EC
Unit voltage [V]	230 / 50 Hz
Max. fan power [W]	187
Fan current [A]	1,1
Electric heater power [kW]	1,5
Electric heater current [A]	6,5
Total unit power [kW]	1,69
Max. unit current [A]	7,6
Max. air capacity [m ³ /h]	270
Noise level, 3 m [dB(A)]	42
Max. transporting air temperature [°C]	from -25 °C up to +60 °C
Casing material	polymer coated steel
Insulation	15 mm (foiled polypropylene foam)
Filter: extract/supply	G4 / G4
Connected duct diameter [mm]	Ø125
Weight [kg]	38/37
Heat recovery efficiency	up to 95%
Heat exchanger type	counter-flow
Heat exchanger material	polystyrene

* - only for the unit VUT 300 (301) EV mini EC without kitchen hood

Table 2. Control Panel Specifications

Ambient Temperature [0C]	from 0 to 40
Relative Humidity [%]	from 5 to 90 (without condensation)
Cable Section [mm2]	from 0.18 to 0.35
Material	ABS Plastic
Dimensions (WxHxD) [mm]	86x86x14
Cable Length [m]	Up to 10
Protection Class	IP30

SAFETY REQUIREMENTS

While operating and mounting the unit consider the requirements of the present operation manual as well as general requirements of all applicable local and national building and electrical codes and standards.

The unit must be grounded!

Before connecting the unit to power mains make sure that the unit is free of any visible damages or any other foreign objects inside the casing that can damage the impeller blades.

All the wireworks with the unit are allowed by a professional electrician, duly authorized for electric operations.

**Warning!**

Disconnect the unit from power supply prior to any mounting, servicing, connection or repair operations with the unit.

**Do not!**

- **Do not operate the unit beyond the specified temperature range or in an aggressive and explosive medium!**
- **Do not connect clothes dryers or similar equipment to the ventilation system!**
- **Do not operate the unit in the air and dust mixture medium!**

STRUCTURE AND OPERATING LOGIC

The unit operating principle is as follows (fig. 3).

Warm stale air from the premises extracted by the unit is purified in the extract filter, then it passes through the heat exchanger and then is exhausted outside through the ducts by the exhaust fan.

Clean cold intake air supplied to the unit is purified in the supply filter.

The air passes through the heat exchanger and then fed into the premises by the supply fan.

Thermal energy of warm extract air is transferred to clean intake fresh air from outside and warms it up. The air flows are fully separated.

Heat recovery minimizes thermal energy losses, energy demand and operating costs for heating during winter time.

The unit is equipped with an electric heater to enable supply air warming up to +30 °C.



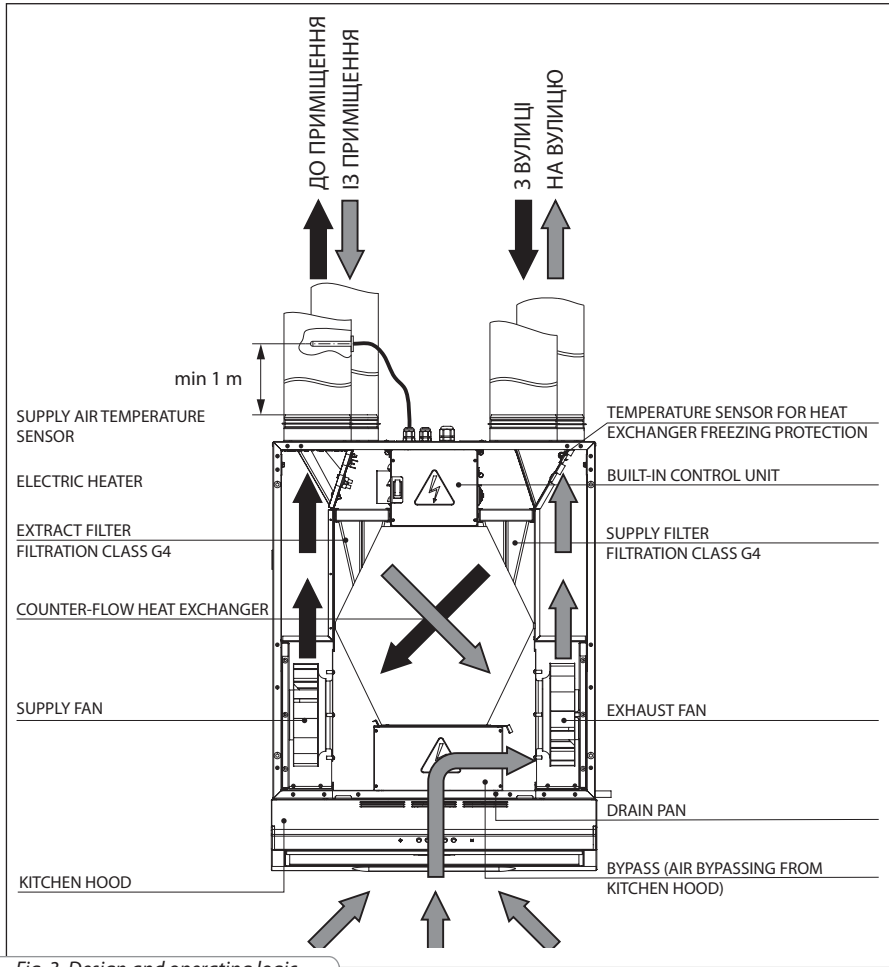

Fig. 3. Design and operating logic

MOUNTING AND SET-UP

Mount the unit to provide enough access for maintenance or repair operations, fig. 4.

The wall for mounting must have even surface.

Any surface irregularities will lead to unit casing skew and may prevent the unit from operating properly.

For the unit fastening use the fasteners recommended by the manufacturer for the specified wall type.

To ensure proper supply air pre-heating install the duct temperature sensor (fig. 3) at the minimum distance of 1 m from the supply spigot.

The supply air duct temperature sensor is installed as follows:

- Drill a $\varnothing 9$ mm hole in the duct;
- Install the sensor into the hole;
- Fasten the sensor flange with three self-tapping screws.

It is recommended that the sensor and air duct joint is hermetically sealed.

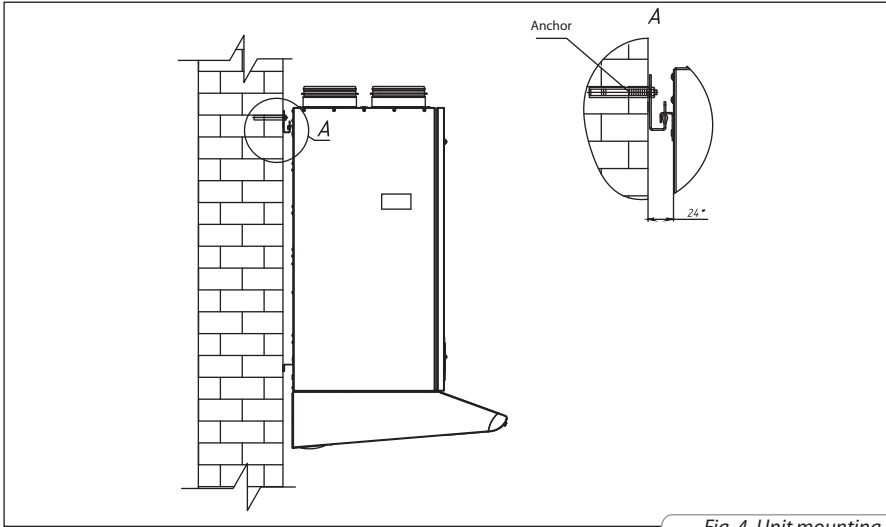

Fig. 4. Unit mounting

Mounting sequence of the wall-mounted control panel:

- Use a screwdriver to lift the latches through the technological openings in the upper part of the wall-mounted control panel, fig. 5.

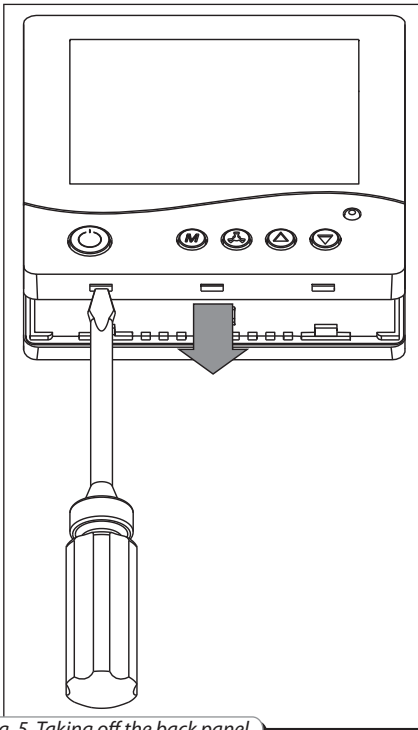

Fig. 5. Taking off the back panel.

- Take off the back cover.
- Disconnect the cable from the terminal block.
- Route the cable to the panel installation site.
- Fix the panel back cover to the wall, fig. 6.
- Connect the cable to the terminal block.
- Put the panel on the latches and press to click.



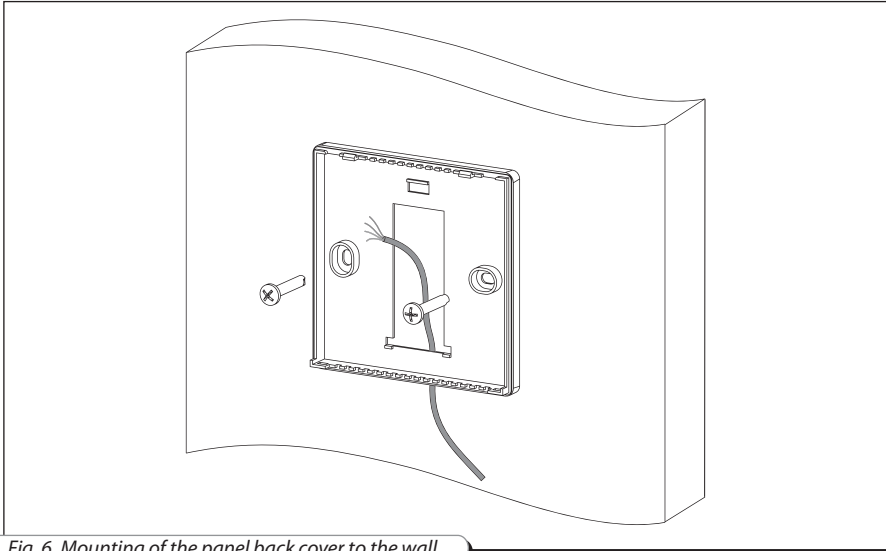

Fig. 6. Mounting of the panel back cover to the wall

CONDENSATE DRAINAGE

The condensate drain pan located in the heat recovery section is equipped with a drain pipe to remove condensate from the unit. Connect a U-trap to the drain pipe. The U-trap and the drain pan must be thermally insulated.

The U-trap height, fig. 7, depends on the pressure inside and outside of the section and must be not less than $H=100$ mm, $h=50$ mm.

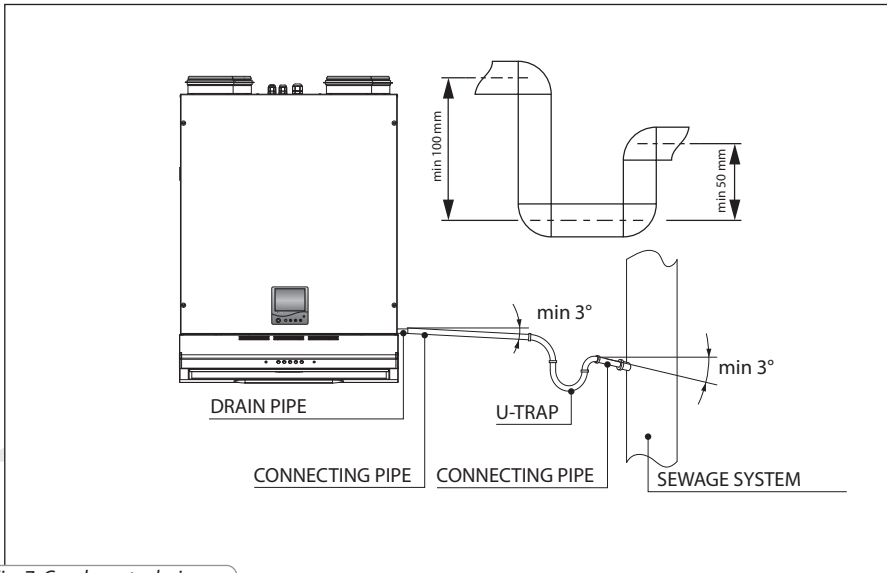

Fig. 7. Condensate drainage

CONNECTION TO POWER MAINS



Disconnect the unit from the power mains prior to any work.
The unit must be plugged into a properly installed power socket with an earthed terminal.
The rated electrical parameters of the unit are stated on the sticker.
Any tampering with the internal connections is prohibited and will void the warranty.

The unit is designed for connection to 230 V / 50 Hz single-phase AC mains.

Proper connection is ensured by the power cable with a Euro plug supplied by the manufacturer.

The unit must be connected to the power mains through an automatic cut-out switch integrated into the stationary wiring with a magnetic breaker with the nominal trip current at least equal to the unit consumption current, refer table 1.

The unit has extra electric connection options. The contact designations are enclosed in brackets on the X3 terminal block sticker, fig. 8.

connection of the automatic fire-fighting system contact (PK)

connection of the humidity relay/sensor or CO2 sensor contact (H)

While connecting the automatic fire-fighting system contact remove the jumper between the X3:1 and X3:2 terminals of the X3 terminal block; in case of fire the dry contact breaks the control circuit from the central fire-fighting board and cuts off power supply to the unit.

The humidity sensor or CO2 sensor is connected to the X3:3 and X3:4 terminals of the X3 terminal block; if the dry contact is closed, the unit turns to the maximum speed.

Extra contacts must be connected in compliance with the wiring diagram, fig. 8. Route the cable through a cable sealing gland on the unit top.

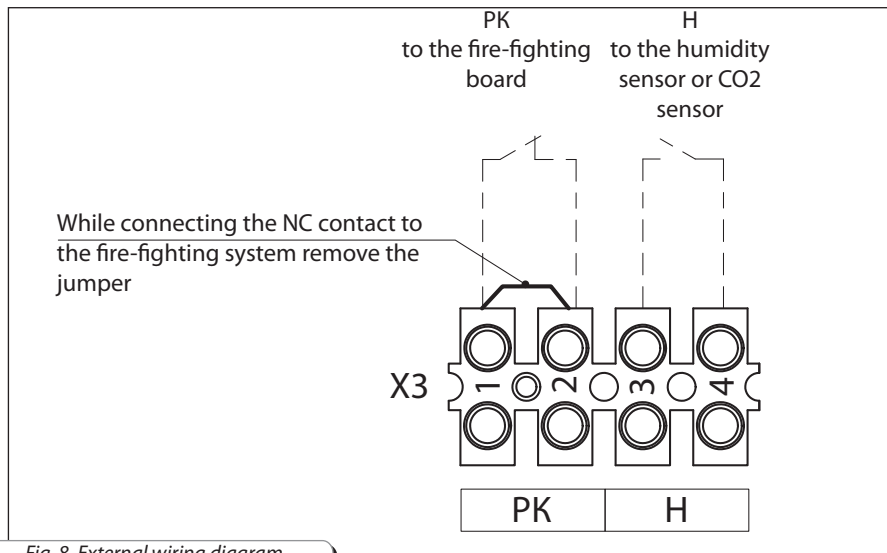
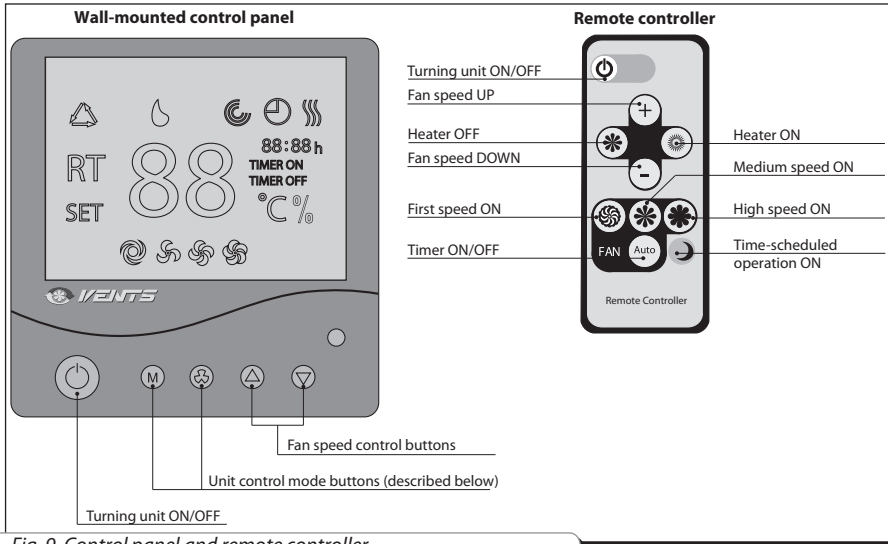

Fig. 8. External wiring diagram



UNIT CONTROL



The unit is controlled from the wall-mounted control panel as well as from the remote controller, fig. 9.



1. Turning unit ON/OFF

To turn the unit ON/OFF:

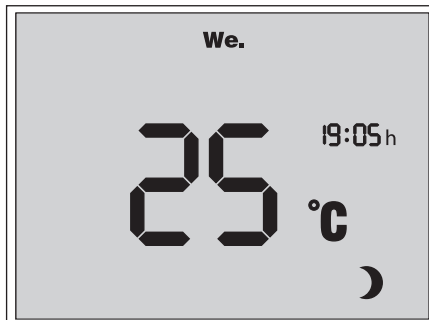
- from the wall-mounted control panel - press the button Turning unit ON/OFF 
- from the remote controller - press the button Turning unit ON/OFF 



The wall-mounted display shows the following indications as the unit is turned off, fig. 10:

- Indoor temperature;
- Weekday;
- Time;
- OFF indication 
- When air supply to the heating elements is activated, the **TIMER ON** and  indicator glows and the countdown of the air supply to the heater time starts (min : s).

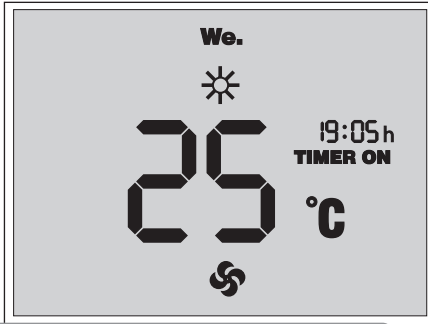





Fig. 11. Display in turned ON







The wall-mounted display shows the following indications as the unit is turned on, fig. 11:

- Indoor temperature;
- Weekday;
- Time;
- Fan speed indicator   ;
- Timer status information;



The indicator **TIMER ON** is displayed as the timer is turned on. The indicator **TIMER OFF** is displayed as the timer is turned off.

- Heater status information. As the heater is turned on, the indicator  is displayed.

2. Unit ventilation mode control.



- From the wall-mounted control panel - press the button  for setting speed up or the button  for setting speed down (low speed - medium speed - high speed);
- From the remote controller - press the button  for setting speed up or the button  for setting speed down (low speed - medium speed - high speed);
- From the remote controller - press the button  to activate low speed, the button  to activate medium speed and the button  to activate high speed.

The wall-mounted control panel displays the current fan speed:

- Indicator  — low speed mode;
- Indicator  — medium speed mode;
- Indicator  — high speed mode.

3. Supply air warming up

The electric heater warms up the supply air up to the set temperature in compliance with the duct temperature set point. To turn the heater ON/OFF:

- from the wall-mounted control panel - press and hold the button  and then press the button .
- from the remote controller: press the button  to turn the heater on, press the button  to turn the heater off.









Warning!

If the heater is on, the unit can be turned off only after 20 seconds after turn-off command to ensure the heater cooling. In this case the indicator  is displayed.

4. Timer.

The timer is designed to switch the fans to maximum speed with subsequent automatic reset to a previous speed after set time period (from 20 to 60 minutes). To turn the timer on/off:

- from the wall-mounted control panel - press and hold the button  and then press the button . Press the button once to set the timer for 20 minutes, each subsequent pressing extends the timer setting for 10 minutes. The maximum timer setting is 60 minutes. Press and hold the button  for 3 seconds to turn the timer off;

- from the remote controller - press the button  to turn the timer for 20 minutes on. To turn the timer off press the button  or .

5. Heat exchanger freezing protection.



- If the temperature in the intake air duct upstream of the heat exchanger is from -7°C up to -15°C , the unit turns into automatic temperature control mode. The supply fan has 5 minutes standstill and then it operates within 25 minutes. If the temperature is below -15°C the supply fan has 5 minutes standstill and then it operates within 15 minutes.

6. Unit setup modes



**Re-adjustment of the unit settings results in loss of the factory settings!
Fan speed and temperature sensor setup is possible only from the wall-mounted control panel!**

Fan capacity setup mode.

The unit operates at low, medium or high speed. The supply and extract fan speeds are smoothly adjustable in setup mode. The fan capacity is adjustable only in the fan speed setup mode. The fan speed setup mode is accessible only when the unit is off. To enter the fan speed setup mode press and hold the button  on the wall-mounted control panel, then press and hold the button  within 3 seconds.

Access to the setup mode is confirmed by the indicator **SET** and **%**, fig. 12 on the wall-mounted control panel display.

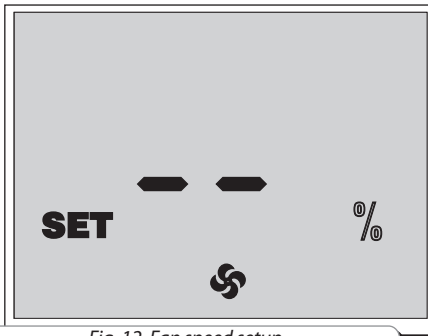







Fig. 12. Fan speed setup

- To select the required speed to be adjusted use the buttons  and .

During fan speed setup the selected speed is displayed by the indications ,  or .

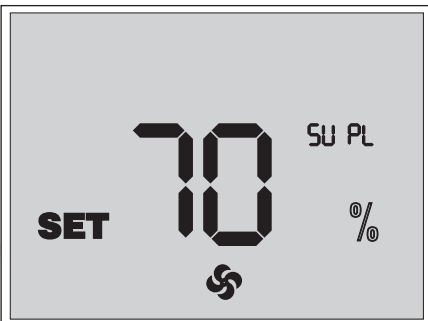

















Fig. 13. Fan speed setup

- To adjust the supply fan capacity press and hold the button  and press the button  to set the fan speed up or the button  to set the fan speed down. Each pressing of the button  and  increases or decreases the supply fan by 1%. If the button  remains pressed the display indicators show the current supply fan speed, fig. 13.

- To adjust the exhaust fan speed press and hold the button  and regulate the speed by the button  for setting speed up and the button  for setting speed down.

Each pressing of the button  and  increases or decreases the exhaust fan speed by 1%. If the button  remains pressed the display indicators show the current exhaust fan speed. To exit the fan speed setup mode and save changes press the button .

Fan speed adjustment is not possible with the remote controller.

To return to the factory settings, enter the fan speed setup mode and synchronously press and hold for 3 seconds the buttons  and .



Factory fan speed settings:

low speed — 40 %

medium speed — 70 %

high speed — 100 %

Duct temperature sensor setup mode.

To enter the temperature sensor setup mode turn the unit off and turn synchronously the buttons  and  on the wall-mounted control panel. Access to the temperature sensor setup mode is confirmed by the indicator **SET** and **°C**.

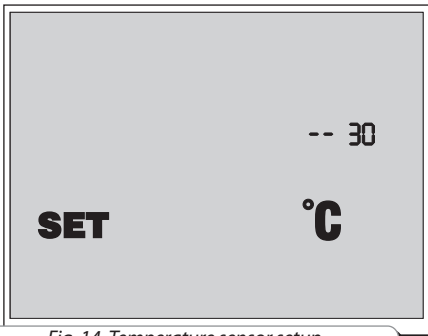



Fig. 14. Temperature sensor setup

- After activation of the setup mode the wall-mounted control panel displays the duct temperature sensor settings, fig. 14.

- Press the button  for temperature setup of the duct temperature sensor. The setup is engaged cyclically with 2 °C interval from +16 °C up to +30 °C.

- Press the button  to review the current temperature sensor readings.

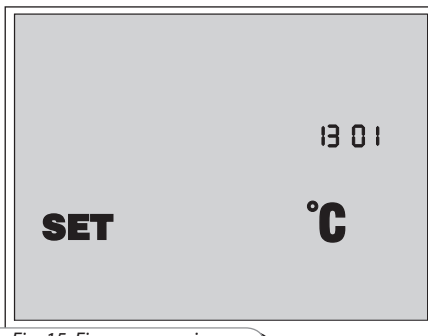



Fig. 15. Firmware version

- Press the button  to display the controller board code and firmware version code on the wall-mounted control panel, fig. 15.

- Press the button  to exit the duct temperature sensor setup mode.

7. Filter replacement signal

As the filter service life expires (3000 hours) the wall-mounted control panel displays a filter replacement indicator **F** instead of the operating temperature, fig. 16.

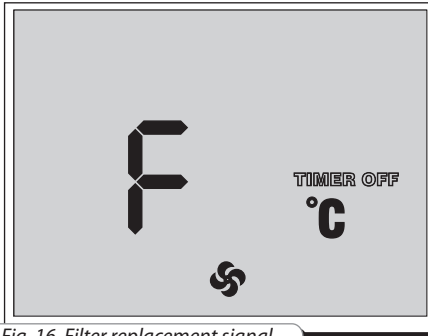

Fig. 16. Filter replacement signal

- In case of the filter replacement signal **F** turn the unit off with the button and disconnect it from power mains. Then replace the filters following the filter replacement procedure in the section «Technical maintenance» on page 19.

- After that press the button on the wall-mounted control panel or the button on the remote controller to turn the unit on. Then press synchronously the buttons and to reset the motor meter.

8. Date and time setup.

- Turn the unit off.
- Press and hold the button , then press the button on the wall-mounted control panel to enter the date and time setup mode.

- Keep the button pressed and select a parameter to be edited using the buttons and .

An editable parameter blinks.

- The date and time setup parameters are located as listed:
1. Minutes;
 2. Hours;
 3. Weekday;
 4. Date;
 5. Month;
 6. Year.

- Then set the required parameter with the buttons and on the wall-mounted control panel.

- Press the button to exit the date and time setup mode.

9. Time scheduled operation.

- Press and hold the button , then press the button on the wall-mounted control panel to activate the time-scheduled operation. The indicator confirms that the unit time-scheduled operation is activated.

- Press and hold the button and then press the button on the wall-mounted control panel.



- Press the button on the remote controller to activate or deactivate the unit time-scheduled operation.

- The timer control always takes precedence of the time-scheduled operation.

10. Time-scheduled operation setup.

Each weekday has four entries that determine the fan switching to a set fan speed, turning the heater on or off.

- To enter the time-scheduled operation setup mode, turn the unit off with the button on the wall-mounted control panel or with the button on the remote controller.

- Press and hold the button  on the wall-mounted control panel and the press the button .

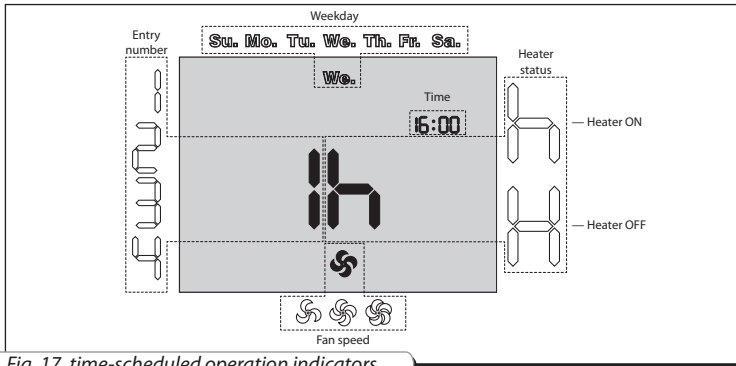











Fig. 17. time-scheduled operation indicators

- Hold the button  and select a required parameter to be adjusted using the buttons  and .
 - Set a required parameter using the same buttons  and .
- Time-scheduled operation parameters, fig. 17.
- Entry number - each weekday has four entries.
 - Weekday - setup of a weekday.
 - Heater status - setup of the heater status for the current entry. **H** - heater on, **h** - heater off.
 - Fan speed - setup of the fan speed for the current entry.
 - Time - time setup for the current entry.
- To copy the set entries for the next day press and hold the button  and press the button . No copying from Sunday to Monday is possible.
 - Press the button  on the wall-mounted control panel or the button  on the remote controller to exit the time-scheduled operation setup mode.

A programming example for setup of the time-scheduled operation is stated in the table 3. By default the time-scheduled operation mode is adjusted for warm season. While adjusting the time-scheduled operation mode set the heater status — **H**.

Table 3. Sample programming sequence

Day	Entry Number											
	1			2			3			4		
	Start Time	Mode	Heater Status	Start Time	Mode	Heater Status	Start Time	Mode	Heater Status	Start Time	Mode	Heater Status
Mo.	07:00	2 speed	Off	08:00	1 speed	Off	17:00	2 speed	Off	22:00	1 speed	Off
Tu.	07:00	2 speed	Off	08:00	1 speed	Off	17:00	2 speed	Off	22:00	1 speed	Off
We.	07:00	2 speed	Off	08:00	1 speed	Off	17:00	2 speed	Off	22:00	1 speed	Off
Th.	07:00	2 speed	Off	08:00	1 speed	Off	17:00	2 speed	Off	22:00	1 speed	Off
Fr.	07:00	2 speed	Off	08:00	1 speed	Off	17:00	2 speed	Off	22:00	1 speed	Off
Sa.	10:00	2 speed	Off	12:00	2 speed	Off	17:00	2 speed	Off	23:00	1 speed	Off
Su.	10:00	2 speed	Off	12:00	2 speed	Off	17:00	2 speed	Off	23:00	1 speed	Off

11. Alarms.

In case of alarm the unit is turned off and the wall-mounted control panel display shows the alarm indicators, fig. 18. The possible alarms are listed in the table 4.

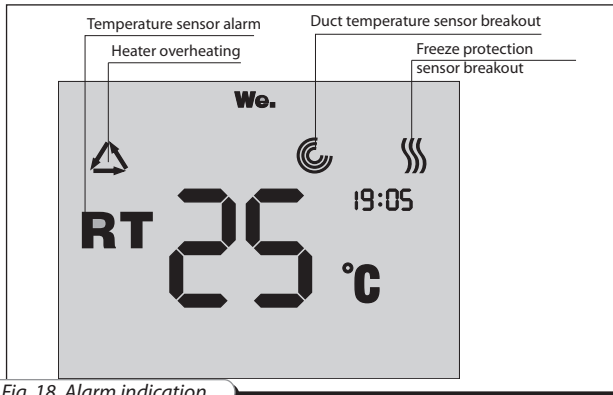

Fig. 18. Alarm indication

Table 4. Unit alarms

ALARM	INDICATION	FAULT HANDLING
Heater overheating.		Heater overheating. Switch the thermal protection thermostats manually.
Temperature sensor alarm	RT	Short circuit of the temperature sensor(s). Remove the short circuit.
Duct temperature sensor breakout	RT	Remove the duct temperature sensor breakout.
Freeze protection sensor breakout	RT	Remove the freeze protection sensor breakout.

12. Kitchen hood control (only for the units VUT 300 (301) EVK mini EC).

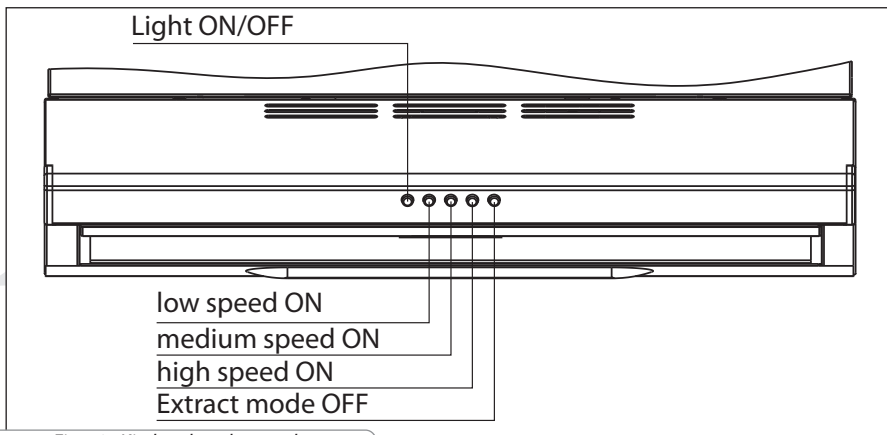

Fig. 19. Kitchen hood control

- Press the respective speed button (low, medium or high speed, fig. 19) to turn the kitchen hood on. The kitchen hood has priority over the control panel, i.e. the control panel is not active when the kitchen hood is on.

- Press the respective button to turn the kitchen hood off, see fig. 19. After turning the kitchen hood off the unit reverts to the operation mode set from the control panel.

The kitchen hood is controlled with the buttons located on the front panel, fig. 16. If the kitchen hood is in operation, the heat recovery function is not engaged because extract air flows passes by the heat exchanger. The unit operates at the speed set by the kitchen hood.

MAINTENANCE

The unit requires maintenance works 3-4 times per year.

Maintenance includes regular cleaning and the following operations:

1. Filter maintenance (3-4 times per year).

Dirty filters increase air resistance in the system and reduce supply air volume. The filters require cleaning as they get clogged, but at least once in 3-4 months.

Vacuum cleaning is allowed. Replace the filters as they get clogged following the second cleaning.

Contact your local manufacturer representative for new filters.

To remove the filters follow the procedure in the fig. 20:

1. Remove the screws.

2. Open the unit access door and disconnect the control panel plug connector (only for the model with a built-in control panel), then unscrew 2 M6 screws to release the stopper. Open the unit access door and lift it upwards to remove it from the supports.

3. Remove the heat exchanger from the unit by pulling its band.

4. Take the supply and extract filter off.

2. Kitchen hood fat filter maintenance (only for the units VUT 300 (301) EVK mini EC (as required)).

To clean the metal fat filters let them soak in hot water mild detergent solution until the fat gets dissolved.

To release the fat filters follow the procedure in fig. 22:

1. Press the latch.

2. Move the fat filter carefully down and release it.

3. Heat exchanger inspection (once per year).

Some dust can get accumulated on the heat exchanger block even in case of regular maintenance of the filters.

To maintain the high heat exchange efficiency, regular cleaning is required.

To clean the heat exchanger pull it out of the unit and flush it with warm soap or mild detergent water solution. Re-install the dry heat exchanger to the unit.

4. Fan inspection (once per year).

Even in case of regular filter and heat exchanger maintenance, some dust and grease can get accumulated inside the fans and reduce the fan performance and supply air flow.

Clean the fans with a soft brush or cloth. No water and abrasive detergent, sharp objects or solvents are allowed for cleaning to prevent the impeller damage.

5. Condensate drainage (once per year).

The drain pipes may get clogged with extracted particles.

Pour some water inside the drain pan and check the pipe for clogging. Clean the U-trap and drain pipe if required.

6. Supply air flow control (twice per year).

Leaves and other pollutions can clog the supply air grille and reduce the unit performance and supply air volume.

Check the supply grille twice per year and clean it as required.

7. Ductworks inspection (once in 5 years).

Even if you follow all the listed maintenance guidelines, some dust can get accumulated inside the air ducts and reduce the unit performance. Duct maintenance means their regular cleaning or replacements.

8. Control unit maintenance (as required).

Maintenance of the control unit must be performed by a qualified electrician duly authorized for unassisted electric operations up to 1000 V. Read the user's manual prior to the control unit servicing! Cut off power supply to the unit prior to the control unit servicing.

While servicing the control unit follow the operations shown in fig. 21:

1. Remove four screws to take off the protecting cover.
2. Remove the heat exchanger from the unit by pulling its band.
3. Remove the screws that fix control block swivel panel. Hold the swivel panel while detaching it.
4. Move the swivel panel downwards.

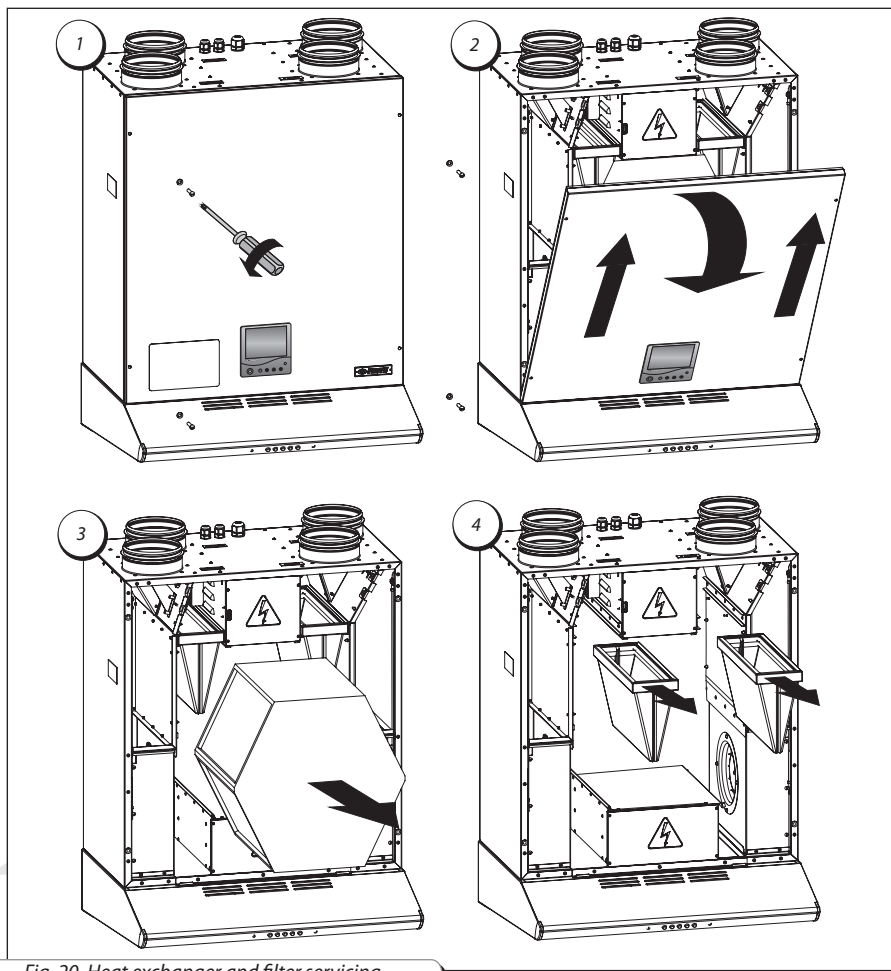

Fig. 20. Heat exchanger and filter servicing

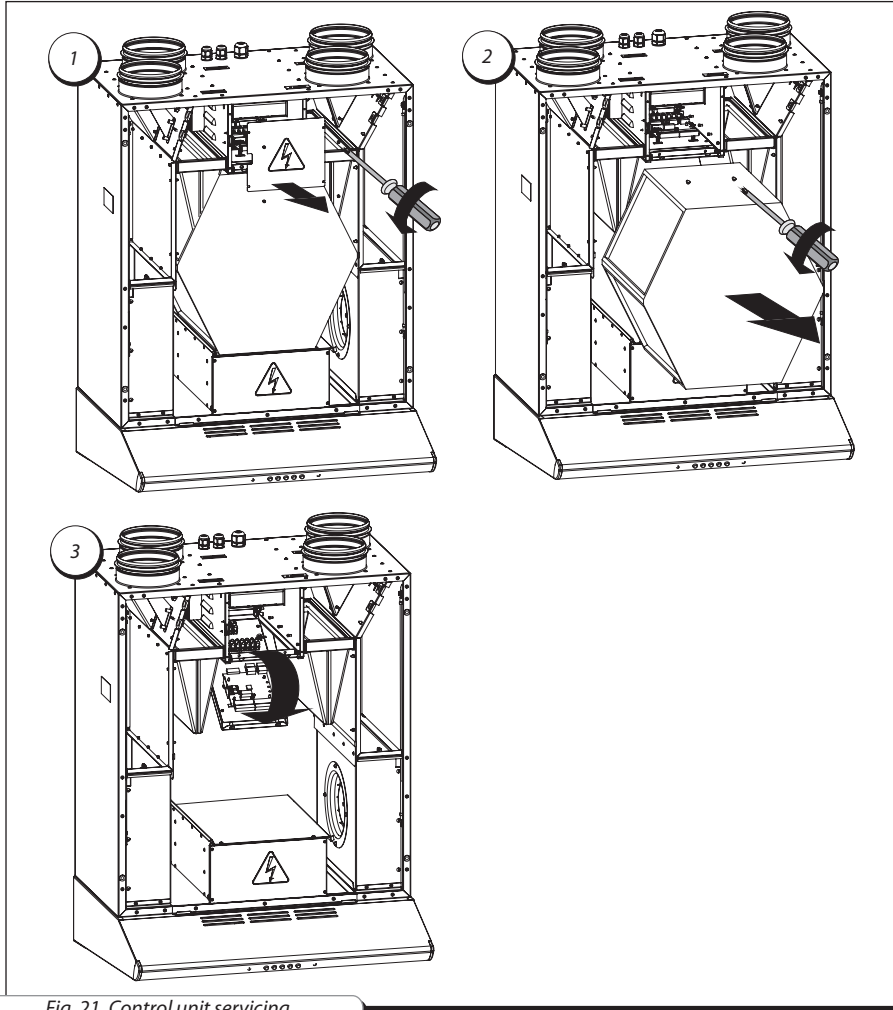

Fig. 21. Control unit servicing

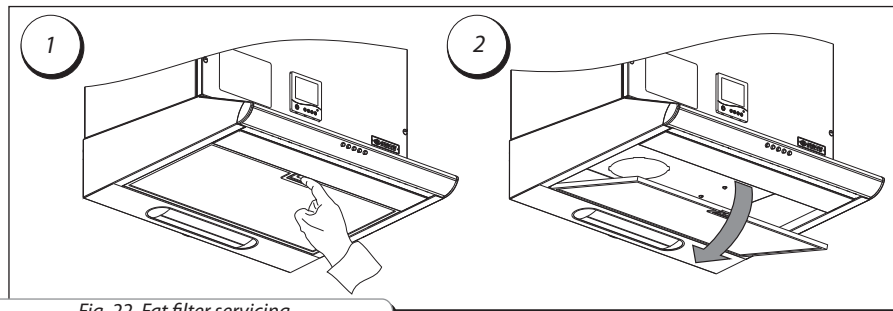

Fig. 22. Fat filter servicing

FAULT HANDLING

Possible faults and fault handling

Problem	Possible reasons	Fault handling
The fans do not get started	No power supply.	Make sure the power supply line is connected correctly, otherwise troubleshoot the connection error.
Cold supply air.	The extract filter is soiled.	Clean or replace the extract filter.
	The heat exchanger is frozen.	Check the heat exchanger for icing. Shutdown the unit if required and turn it on after the freezing danger is no longer imminent.
	The heater malfunction.	Please contact the service center.
Low set air flow.	The filters, the fans are soiled, the heat exchanger is soiled.	Clean or replace the filters; clean the fans and the heat exchanger.
	The ventilation system is soiled or damaged.	Check opening of the diffusers and louvre shutters, check the extract hood and supply grille and clean it if required; make sure the air ducts are not soiled and not damaged.
Low air flow when the kitchen hood operates	The fat filter is clogged	Clean the metal fat filter.
Noise, vibration	The impeller is clogged.	Clean the fan impeller.
	Loose screw tightening.	Tighten the screws to stop.
Water leakage.	The drain system is soiled, damaged or wrong arranged or wrong slope angle of the unit toward the drain system.	Clean the drain system. Check the drain slope angle. Make sure that the U-trap is filled with water and the drain pipes are frost protected.



STORAGE AND TRANSPORTATION RULES

Store the unit in the manufacturer's original packing box in a closed ventilated premise with temperature range from +10°C to +40°C and relative humidity less than 80% (at +20°C).

Vapours or particles which can cause corrosion or damage the insulation or connection tightness are not allowed in the storage environment.

Use hoist machinery for handling and transportation to prevent possible mechanical damages of the unit.

Fulfill the requirements for transportation of the specified cargo type during cargo-handling operations.

Use any vehicle types for the unit transportation provided that it is protected against mechanical or weather damage.

Avoid any mechanical shocks and strokes during handling operations.

MANUFACTURER'S WARRANTY

Manufacturer hereby guarantees normal performance of the unit during two years from the date of retail sale provided compliance with transport, storage, mounting and operation regulations.

In case of no confirmation of the sales date the warranty period is calculated from the manufacturing date.

In case of failures in the unit operation during the warranty period the manufacturer will accept reclamations and complaints from the owner of the device only after receiving technically sound act with detailed description of the failure.

Unit damage as a result of unauthorized tampering with the circuit diagram is not a warranty case.

For warranty and post-warranty services of the unit please contact the product manufacturer.

In case of warranty claim please submit the present user's manual with the seller's stamp, filled connection certificate and warranty card.

Warranty repair services and post-warranty services are fulfilled at the manufacturing facility.



WARRANTY CLAIMS ARE ACCEPTED WITH THIS USER'S MANUAL AND FILLED CONNECTION CERTIFICATE ONLY.



The MANUFACTURER is not responsible for any mechanical or physical damages resulting from the manual requirements violence, the unit misuse or gross mechanical effect.

Fulfill the requirements set in the user's manual to ensure proper functioning of the unit.



ACCEPTANCE CERTIFICATE

The air handling unit with heat recovery VUT 300(301) EV (K) mini EC has been duly certified as serviceable.

We hereby declare that the product complies with the essential protection requirements of Electromagnetic Council Directive 2004/108/EC, 89/336/EEC and Low Voltage Directive 2006/95/EC, 73/23/EEC and CE-marking Directive 93/68/EEC on the approximation of the laws of the Member States relating to electromagnetic compatibility.

This certificate is issued following test carried out on samples of the product referred to above.

Acceptance Inspector's Stamp _____ Date of manufacture _____

Sold by

Seller's name and stamp _____

Date of sale _____

ELECTRICAL CONNECTION CERTIFICATE

This is to certify that the air handling unit with heat recovery VUT 300(301) EV (K) mini EC has been connected to power mains pursuant to the requirements stated in the present user's manual by a qualified technician:

Company name _____

Electrician's name _____

Date _____ Signature _____

WARRANTY CARD

