

Round duct

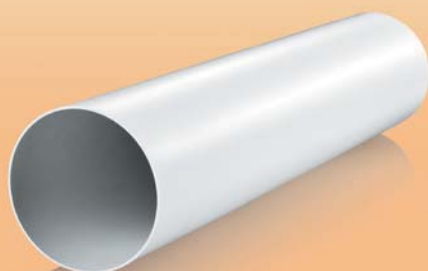

Application

- Supply and exhaust ventilation of various premises.
- Formation of round air ductworks.

Design

- Made of white PVC.
- Diameters: 100, 125, 150 and 200 mm.
- Duct length from 350 to 2500 mm.
- Connected with matching diameter connectors.

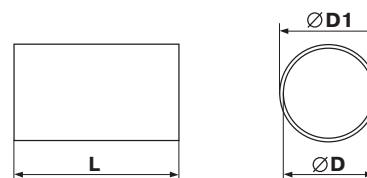

Code	Dimensions [mm]		
	D	D1	L
10035	100	103	350
20035	125	128	350
30035	150	153	350
40035	200	204	350
1005	100	103	500
2005	125	128	500
3005	150	153	500
4005	200	204	500
1010	100	103	1000
2010	125	128	1000
3010	150	153	1000
4010	200	204	1000
1015	100	103	1500
2015	125	128	1500
3015	150	153	1500
4015	200	204	1500
1020	100	103	2000
2020	125	128	2000

Code	Dimensions [mm]		
	D	D1	L
3020	150	153	2000
4020	200	204	2000
1025	100	103	2500
2025	125	128	2500
3025	150	153	2500
4025	200	204	2500
10035/2	104	107	350
20035/2	129	132	350
1005/2	104	107	500
2005/2	129	132	500
1010/2	104	107	1000
2010/2	129	132	1000
1015/2	104	107	1500
2015/2	129	132	1500
1020/2	104	107	2000
2020/2	129	132	2000
1025/2	104	107	2500
2025/2	129	132	2500

Round telescopic duct



Application

- Supply and exhaust ventilation of various premises.
- Wall mounting.

Design

- Made of white PVC.
- Telescopic design of two parts.
- Diameters: 100, 125, 150 mm.
- Air duct length is adjusted within 300 to 500 mm or 500 to 1000 mm.

Code	Dimensions [mm]				
	D	D1	D2	D3	L
1805	100	103	104	107	300-500
2805	125	128	129	132	300-500
3805	150	153	154	157	300-500
1810	100	103	104	107	500-1000
2810	125	128	129	132	500-1000
3810	150	153	154	157	500-1000

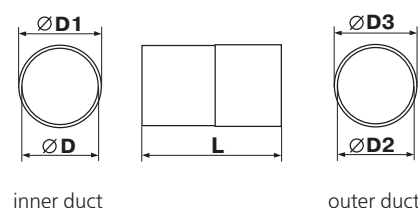

inner duct

outer duct

Round flexible duct connector



Application

- Supply and exhaust ventilation of various premises.
- Connection of flexible round ducts.

Design

- Made of white PVC.
- Cover the connector with air duct and fix it with clamps.
- Connecting diameters: 100, 125, 150, 200 mm.

Code	Dimensions [mm]		
	a	D	D1
1113	60	100	103
2123	60	125	128
3133	60	150	153
4143	60	200	204

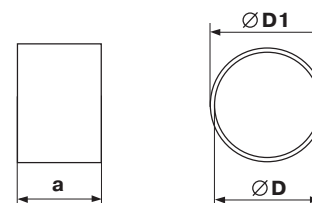

90° bend for round ducts



Application

- Supply and exhaust ventilation of various premises.
- Connection of same diameter air ducts at 90°.

Design

- Made of white plastic.
- Connecting diameters: 100, 125, 150 mm.

Code	Dimensions [mm]			
	D	D1	a	b
121	100	97	137	30
222	125	122	164	30
323	150	147	189	30

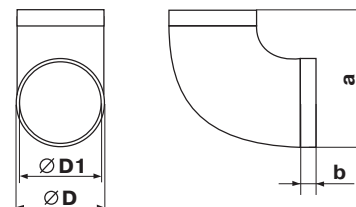

T-joint for round ducts



Application

- Formation of branch connections in supply or exhaust ventilation systems located in residential, public and other buildings.
- Connection of same diameter round ducts and integration into complex ventilation systems.

Design

- Made of white plastic.
- Connection of same diameter three round ducts at 90°.
- Connecting diameters: 100, 125, 150 mm.

Code	Dimensions [mm]				
	D	D1	a	b	c
131	100	97	173	30	139
232	125	122	198	30	164
333	150	147	223	30	189

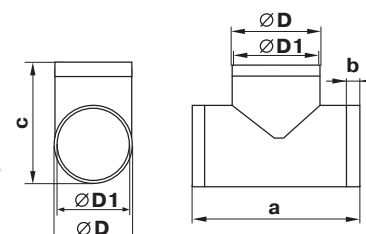

Wall plate for round ducts



Application

- Supply and exhaust ventilation of various premises.
- Connection of air ducts to ventilation shafts.
- Decoration of mounting openings.

Design

- Made of white plastic.
- Screw fixing to wall.
- Connecting diameters: 100, 125, 150, 200 mm.

Code	Dimensions [mm]			
	D	h	a	b
15	103	3	150	134
25	128	3	170	154
35	151	3	204	188
45	204	3	284	268

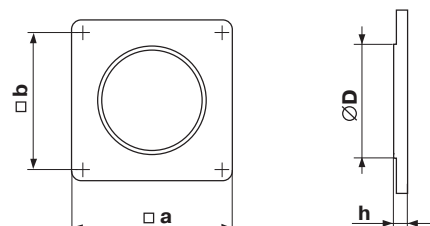

Round duct connector



Application

- Supply and exhaust ventilation of various premises.
- Connection of same diameter air ducts.

Design

- Made of white plastic.
- Designed for direct installation into air duct and equipped with a lock ring.
- Connecting diameters: 100, 125, 150, 200 mm.

Code	Dimensions [mm]		
	D	D1	a
111	100	96	62
212	125	123	62
313	150	148	62
414	200	197	62

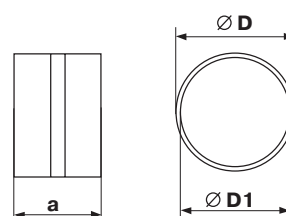

Connector with backdraft damper for round ducts



Application

- Supply and exhaust ventilation of various premises.
- Connection of same diameter air ducts.

Design

- Made of white plastic.
- Equipped with a backdraft damper for back flow prevention.
- Designed for direct installation into air duct and equipped with a lock ring.
- Connecting diameters: 100, 125, 150, 200 mm.

Code	Dimensions [mm]		
	D	D1	a
1111	100	96	62
2121	125	123	62
3131	150	148	62
4141	200	197	62

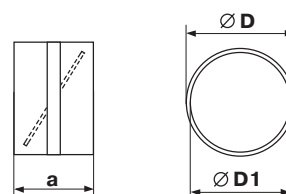

Connector with backdraft damper and wall plate for round ducts



Application

- Supply and exhaust ventilation of various premises.
- Connection of same diameter air ducts.
- Decoration of mounting openings.

Design

- Made of white plastic.
- Equipped with a wall plate for decoration of mounting openings.
- Equipped with a backdraft damper for back flow prevention.
- Screw fixing to wall.
- Connecting diameters: 100, 125, 150, 200 mm.

Code	Dimensions [mm]			
	a	b	c	D
1511	150	134	62	100
2521	170	154	62	125
3531	204	188	62	150
4541	284	268	62	200

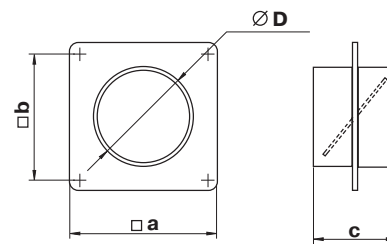

Connector with plate for round ducts



Application

- Supply and exhaust ventilation of various premises.
- Connection of same diameter air ducts.
- Decoration of mounting openings.

Design

- Made of white plastic.
- Equipped with a wall plate for decoration of mounting openings.
- Screw fixing to wall.
- Connecting diameters: 100, 125, 150, 200 mm.

Code	Dimensions [mm]			
	a	b	c	D
151	150	134	62	100
252	170	154	62	125
353	204	188	62	150
454	284	268	62	200

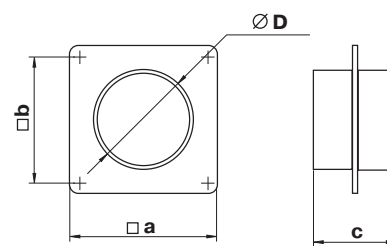

Reducer



Application

- Supply and exhaust ventilation of various premises.
- Connection of various diameter air ducts.

Design

- Made of white plastic.
- Connecting diameters: 80-100, 100-120, 100-125, 100-150, 125-150, 150-200 mm.

Code	Dimensions [mm]				
	a	D1	D2	D3	D4
110	60	103	100	76	80
211	60	129	125	96	100
311	96	154	150	98,5	100
312	60	154	150	121	125
413	71	204	200	146	150
611	60	124	120	98.5	99

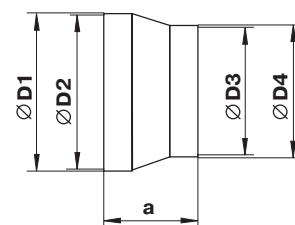

Reducer



Application

- Supply and exhaust ventilation of various premises.
- Connection of \varnothing 120 and 125 mm round air ducts.

Design

- Made of white plastic.
- Connecting diameters: 125-129 mm.

Code	Dimensions [mm]				
	a	D1	D2	D3	D4
216	42	129	125	115	119

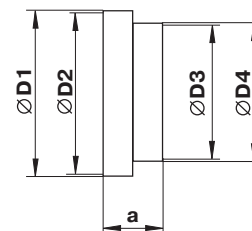

Round step reducer



Application

- Supply and exhaust ventilation of various premises.
- Connection of various sized air duct.

Design

- Made of white plastic.
- Connecting diameters: 80-100-120-125-150 mm.
- Cut out spare length piece to get the required size.

Code	Dimensions [mm]	
	a	Ø
310	125	80-100-120-125-150

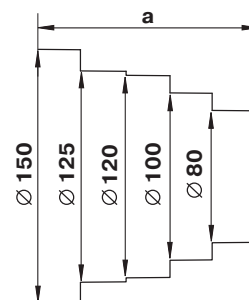

Eccentric reducer



Application

- Supply and exhaust ventilation of various premises.
- Connection of round ducts.

Design

- Made of white plastic.
- Connecting diameters: 100, 120, 125, 130, 150 mm.

Code	Dimensions [mm]						
	a	D1	D2	D3	D4	D5	D6
2118	90	125	120	123	103	99	-
3128	96	151	148	152	132	129	125

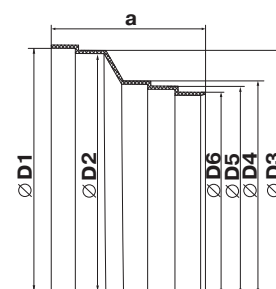
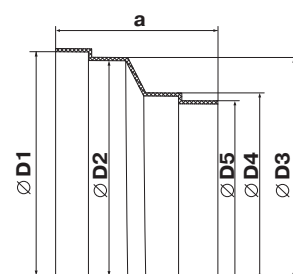

Round to flat connector



Application

- Supply and exhaust ventilation of various premises.
- Connection of round and flat ducts.

Design

- Made of white plastic.
- Direct connection to round and flat ducts.
- Connecting ducts: 100-55x100, 100-60x122, 125-60x204 mm.

Code	Dimensions [mm]						
	a	a1	b	b1	D1	D2	L
511	113	110	59	55	103	100	137
711	124	122	64	60	103	100	137
812	208	204	64	60	128	125	140

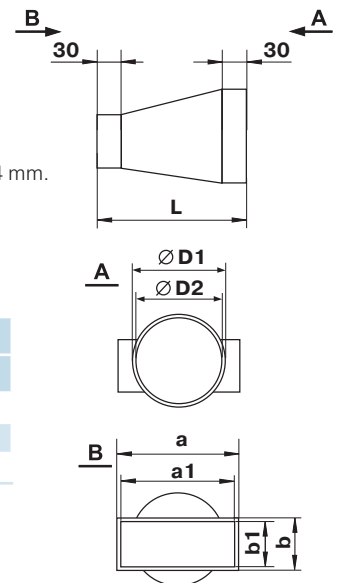

Round flexible duct connector



Application

- Supply and exhaust ventilation of various premises.
- Connection of flexible ducts with plastic system components.

Design

- Made of white plastic.
- Connection to flexible air ducts without clamps.
- Flexible spiral seam duct is connected to one side and the other side is connected to \varnothing 100 mm flange.
- Left or right (R) thread. Right thread connectors are used with Polyvents air ducts.

Code	Dimensions [mm]				
	A	B	C	D	E
1214	90	30	60	100	110
1214R	90	30	60	100	110

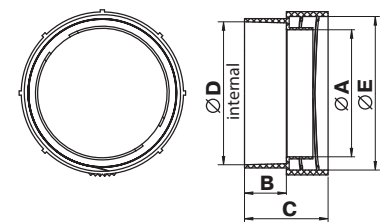

Round flexible duct connector



Application

- Supply and exhaust ventilation of various premises.
- Connection of flexible ducts with plastic system components.

Design

- Made of white plastic.
- Connection to flexible air ducts without clamps.
- Flexible spiral seam duct is connected to one side and the other side is connected to \varnothing 100 mm air duct.
- Left or right (R) thread. Right thread connectors are used with Polyvents air ducts.

Code	Dimensions [mm]				
	A	B	C	D	E
1215	90	30	60	100	110
1215R	90	30	60	100	110

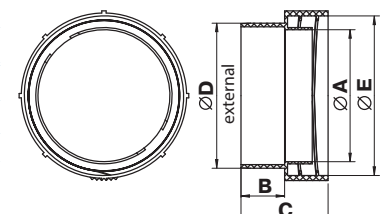

Holder for round ducts



Application

- Supply and exhaust ventilation of various premises.
- Mounting of round ducts to wall, ceiling or any other plane surface.

Design

- Made of white plastic.
- Fixation to plane surface with screws.
- Special snaps provide reliable fixation of the duct with the holder.
- Connecting diameters: 100, 125, 150, 200 mm.

Code	Dimensions [mm]		
	a	b	D
16	113	20	103
26	138	20	128
36	163	20	153
46	213	20	203

