

MONO-PIPE EXHAUST VENTILATION OF BATHROOM AND KITCHENS VENTS VN



2011

*Fresh air in
your house!*



Energy saving ventilation. Air handling units (Catalogue no. 2)

Energy saving supply and exhaust units and air handling units with heat recovery with air capacity up to 6500 m³/h.



Air handling units AIRVENTS (Catalogue no. 3)

Energy saving air handling units with air capacity up to 40 000 m³/h, for use in large residential, industrial and commercial objects.

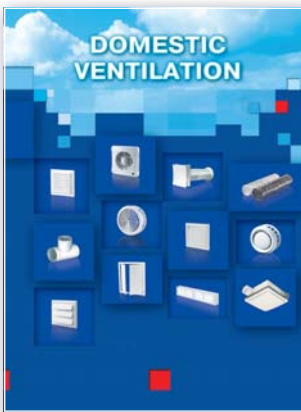

Domestic ventilation (Catalogue no. 6)

Domestic ventilation: fans, mono-pipe exhaust kitchen and bathroom fans, air distribution units, air ducts and connecting elements, access doors, ventilation kits.



Domestic fans (Catalogue no. 7)

Domestic fans with air capacity up to 365 m³/h with extra functions: timer, humidity sensor, motion sensor, etc. Applied for premises up to 30 m².



Access doors (Catalogue no. 10)

Plastic and metal access doors for accessing concealed equipment and utility lines. Special offers for ceramic tiles.



Plastic grilles for ventilation and air conditioning. (Catalogue no. 11)

PROFIPLAST extruded plastic grilles for ventilation and air conditioning.



Flexible ducts and fittings for ventilation, air conditioning and heating. (Catalogue no. 14)

Flexible and semi-flexible air ducts made of polymeric materials, aluminium, galvanized or stainless steel, metal fittings for ventilation, air conditioning, heating, gas handling and abrasive substances aspiration.

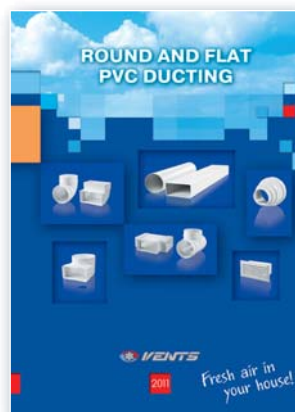

Flat and round PVC air ducts (Catalogue no. 15)

Flat and round PVC ducts PLASTIVENT for ventilation of residential, office and commercial premises and connection of exhaust ventilation equipment (kitchen extractors, hoods, exhaust boxes, etc). Wide product range of fittings.

2011

CATALOGUES

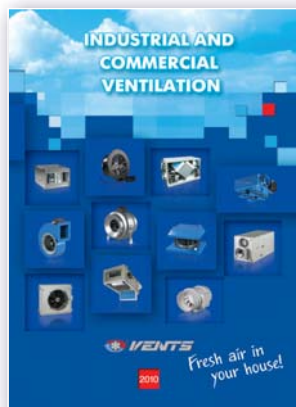

Industrial and commercial ventilation (Catalogue no. 1)

Industrial and commercial ventilation components - fans for round and rectangular ducts, sound-insulated, axial and roof fans, air handling units with heat recovery, air heating units, accessories.

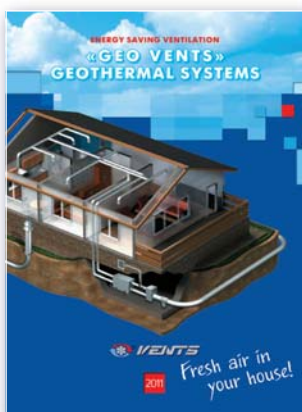

Energy saving ventilation Geothermal systems GEO VENTS (Catalogue no. 4)

Energy saving system GEO VENTS with use of the earth's surface layers heat. Increasing of ventilation system energy efficiency and reducing operating costs.



Fire and smoke damper KPDU (Catalogue no. 5)

Fire dampers KPDU for smoke protection systems of buildings and premises.

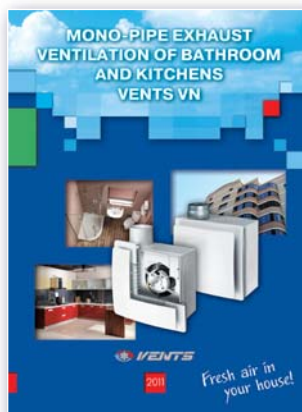

VENTS VN Mono-pipe exhaust ventilation (Catalogue no. 8)

Exhaust ventilation in houses with mono-pipe ventilation system with VENTS VN fans.

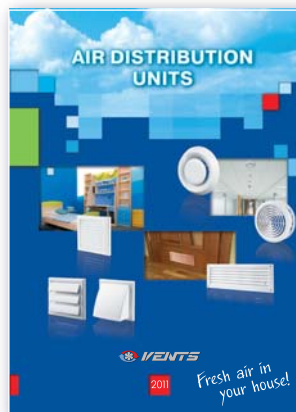

Air distribution units (Catalogue no. 9)

Plastic and metal air distribution products (grilles, disk valves, diffusers etc) for ventilation, air conditioning and heating.



Metal grilles for ventilation, air conditioning and heating. (Catalogue no. 12)

Metal grilles made of extruded metal profile for ventilation and air conditioning.



Spiral seam air ducts (Catalogue no. 13)

SPIROVENT spiral seam ducts and fittings of 100 to 1600 mm diameter for main ventilation systems.

CONTENT

	About VENTS	page 4
	Ventilation in your house	page 6
	Design and modifications of VN fans	page 8
	Ventilation unit VNV-1 80 Air capacity up to 150 m ³ /h	page 10
	Ventilation unit casings for wall flush mounting Fireproof casing – KP 80 Plastic casing – KV 80 Plastic casing with fire-retarding damper – KVK 80	page 12
	Fans for wall flush mounting Fan in fireproof casing – VNV-1 80 KP Fan in plastic casing – VNV-1 80 KV Fan in plastic casing with fire-retarding damper – VNV-1 80 KVK	page 14
	Fans for wall surface mounting Fan in plastic casing – VN-1 80 Fans in plastic casing – VN 80 Fan in plastic casing with fire-retarding damper – VN-1 80 K Fan in plastic casing with fire-retarding damper – VN 80 K	page 20
	Accessories	page 24
	Air shaft calculation in multi-storey buildings	page 26
	Wiring diagrams	page 28
	Ventilation system arrangement example	page 30
	Certificates	page 31



WELCOME TO THE VENTS WORLD!

VENTS company was founded in the 90th years of the XXth century. Dynamic development of the enterprise and ongoing study of consumer demand enabled rapid international leadership in the ventilation industry.

VENTS company is one of the few companies to manufacture independently a wide range of products for development of ventilation systems of any complexity. The corporate affiliates are located nearly in each country and make the VENTS product easy available for the consumers worldwide.

VENTS is a powerful research and development enterprise with approximately 2000 staff ensuring full production cycle from idea to end product. The production base of the company is located at more than 60 000 m² area. It includes 12 workshops equipped under the international standards and each of them performs the function of a separate plant.

Modern equipment, active implementation of advanced technologies and highly automated production are the characteristic features of VENTS company.

The company undergoes progressing development, fundamental researches and effective designs in climatic equipment industry are in the focus of the company's business strategy.

Own design department, test laboratories and production workshops enable supplying the products of high quality to market.

Special attention is paid to the manufacturing of the goods during all manufacturing stages including monitoring the technological conditions. Technical characteristics of supplied raw materials are thoroughly checked. Quality control system which meets international standard requirements ISO 9001:2000 was implemented at the enterprise.

Environmental protection is one of the basic components for the corporate development. The whole technological process at the enterprise is arranged in such a way as to exclude any negative impact for the environment. To solve the global energy saving problem we develop special climatic equipment ensuring comfortable conditions for people and reducing the energy consumption significantly.



Metal workshop



Injection Molding workshop



Extrusion workshop



Domestic fan workshop



Plastic grille workshop



Commercial fan workshop



Industrial fan workshop



Air handling units workshop



Spiral wound ducts workshop

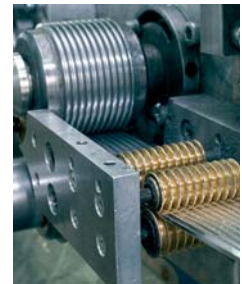

Flexible Ducts workshop

VENTS is the only exporter of ventilation equipment in Ukraine. Our goods gained consumers' acceptance in more than 80 countries of the world including the countries of Europe, America, Asia and Australia that confirms the company reliability and excellent quality of the products. Since 2008 our company is the only Ukrainian manufacturer being the member of the USA Ventilation and Conditioning Association HARDI. Worldwide recognition witnessed that VENTS is the leader of the world ventilation market.



Cooperation with VENTS provides you with the maximum range of products of the top quality from one manufacturer.

VENTILATION IN YOUR HOUSE

Fast development and boost of the building industry, new advanced construction technologies have set special requirements not only to the building design but also to the internal engineering systems as water-supply, sewage system and, no doubt, ventilation.

The state-of-the-art high-rise construction demands mechanical and energy-saving ventilation. Mono-pipe ventilation system that enables air exhaust from several premises through a single ventilation shaft is the most common solution for such application. Several flats can be connected to one ventilation shaft. Correct ventilation arrangement is of special importance for flat reconstruction and rearrangements.

The flexible ventilation system is the ideal solution just for such cases. It is designed at the construction stage and meets a number of important requirements such as fire safety, minimum mounting space, modern design, simple functions and operation modes of the fans for maximum comfort in the apartment. VENTS VN fans fully meet these requirements as they combine maximum operating efficiency and absolute fire safety (modification in fireproof casing).

VENTILATION ARRANGEMENT IN RESIDENTIAL HOUSES WITH MONO-PIPE SYSTEM

Fresh air intake

Fresh intake air from outside is supplied free of dust with low noise level through intake devices such as window or wall vent to bedrooms and living quarters. The vents are suitable for wall- and window installation and provide air flow regulation.

Extract air removal

The extract air from living premises is removed through kitchen, toilet, bathroom and other non-residential premises into the common exhaust ventilation system by high-efficient VN fans.

Fire prevention

To prevent penetration of fire and smoke through the ventilation system air ducts in case of fire the following solutions are used:

1. Fireproof casing

High fire-retarding characteristics of the casing allow using the fan to meet the increased fire-prevention requirements for high-rise residential construction. Fire resistance rating is E90/160.

2. Fire damper

Installed in the ducts laid out through fireproof walls and ceilings. The damper fire resistance rating is EIS 120.

For more details refer the respective sections, page 12 and page 25.

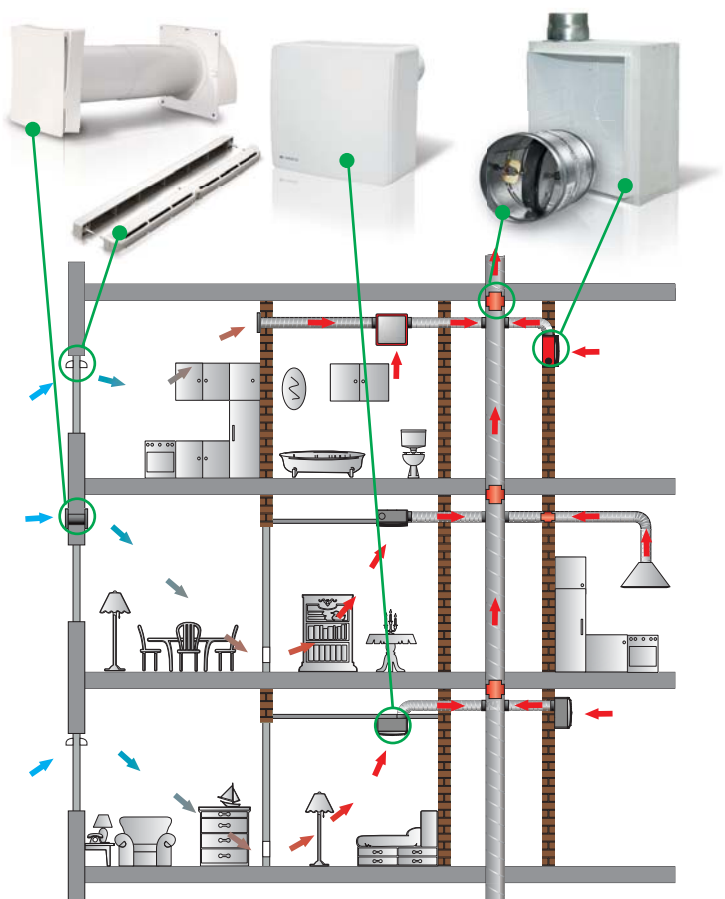

Various international norms and standards	Premise type		
	Kitchens	Bathrooms	WC
	m ³ /h	m ³ /h	m ³ /h
DIN 18017/3	60-100	40 - 60	20 - 30
DIN 1946/6	40 - 60	40 - 60	20 - 30
ECE Compendium	36 - 180	36 - 180	-
BSF 199838	36 - 54	36 - 108	36
ČR	100 - 150	60	25

Hygienic standards demand forced mechanical ventilation of bathrooms and toilets in the flats, hotels and other buildings (see the table). A mono-pipe ventilation system based on VENTS VN fans has convincing advantages as compared to other exhaust ventilation solutions.



The VENTS VN fans combine a number of unique features:

- the fan maintains permanent high pressure level and changes the turbine rotation speed automatically as a function of the resistance level in the system;
- special accessories make the VENTS VN fan a completely fire-proof unit recommended for use in high-rise construction;
- fan speed switching system allow selecting the best operation mode while installment;
- the fan is suitable for continuous non-stop operation. The automatic switch to increased capacity mode is provided;
- due to low noise level (~ only 26 dBA at the lowest speed) this fan type is considered the quietest one within its model range.

The VN fans maintain high pressure in the duct systems due to increasing the rotation speed depending on the resistance fluctuation in the system and keep the constant air flow rate while:

- synchronous operation of many fans integrated into one ventilation system;
- maximum load on the assembled air duct;
- insufficient air intake;
- high resistance of the roof hood.



Well balanced turbine, intellectual casing design and automatic operation mode selection ensure low-noise operation of the VN fans.



FANS FOR WALL FLUSH MOUNTING

VNV-1 80 KP — fan in fireproof casing



VNV-1 80 KV — fan in plastic casing

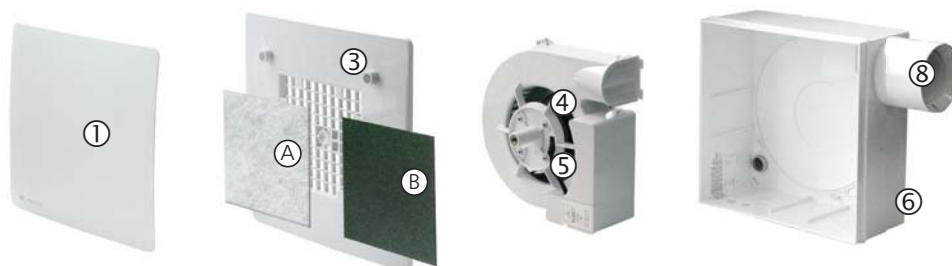

VNV-1 80 KVK — fan in plastic casing with fire-retarding damper

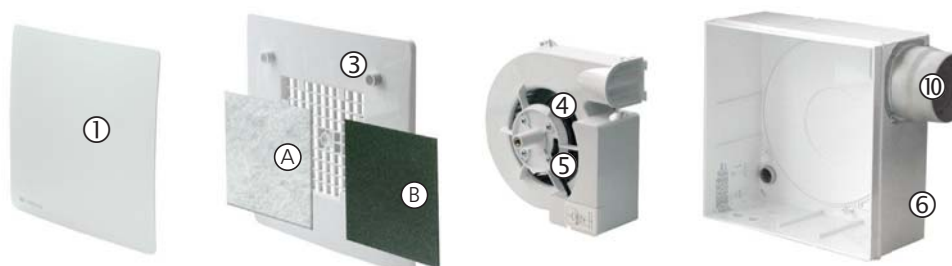

- ① **Front panel**
The compact design and easy mounting makes the fan match well with any room interior. Removable panel provides easy access to the filter.
- ② **Grille**
The ornamental grille serves as a front panel of the fan. The grille design enables easy access to the filter elements and internal part of the fan.
- ③ **Filter**
For protection of the motor, impeller and the assembled air duct from penetration of dust and dirt carried with the air. The filtering element is made from polyether (A) for G4 purification class or from polyurethane foam (B) for G3 purification class.
- ④ **Scroll casing**
Made of durable ABS plastic. The unique design provides attaining the best aerodynamic characteristics during the fan operation. The fan is easily mounted into the casing by means of latches.
- ⑤ **Motor**
The design of two or three speed motor with ball bearings developed in cooperation with **ebmpapst** company, the leading motor manufacturer, ensures reliability and durability of the fan. The fan can automatically switch to the required capacity level depending on the system resistance. Automatic selection of the best operation mode let save energy considerably. The impeller has forward curved blades and is dynamically balanced for precise characteristics, low noise level and safe operation while assembly.
- ⑥ **Plastic casing for flush mounting to wall**
Installed into a wall during general construction works. The casing is made of high-quality durable ABS plastic. It is equipped with a backdraft damper and has additional flanges for connection to branch pipes for adjacent room ventilation.
- ⑦ **Plastic casing for wall surface mounting**
Made of high-quality durable ABS plastic and equipped with a backdraft damper.

FANS FOR WALL SURFACE MOUNTING

VN-1 80 — fan in plastic casing

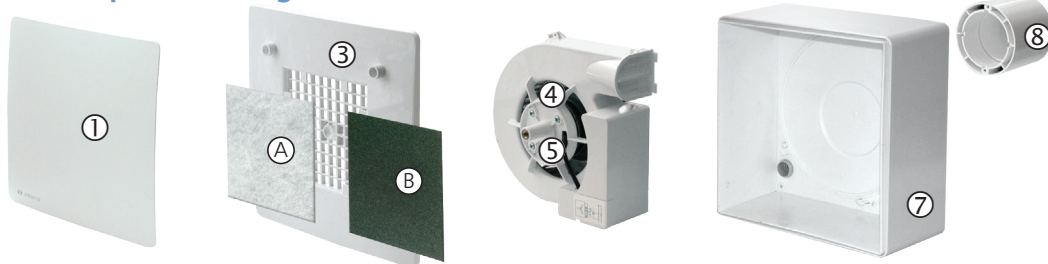

VN-1 80 K — fan in plastic casing with fire-retarding damper



VN 80 — fan in plastic casing

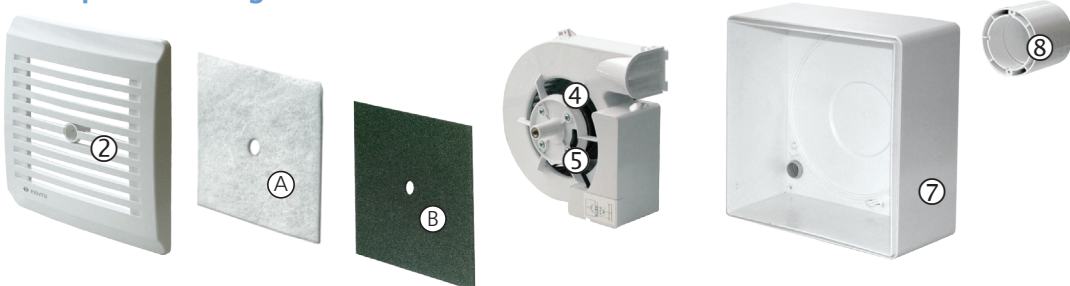

VN 80 K — fan in plastic casing with fire-retarding damper

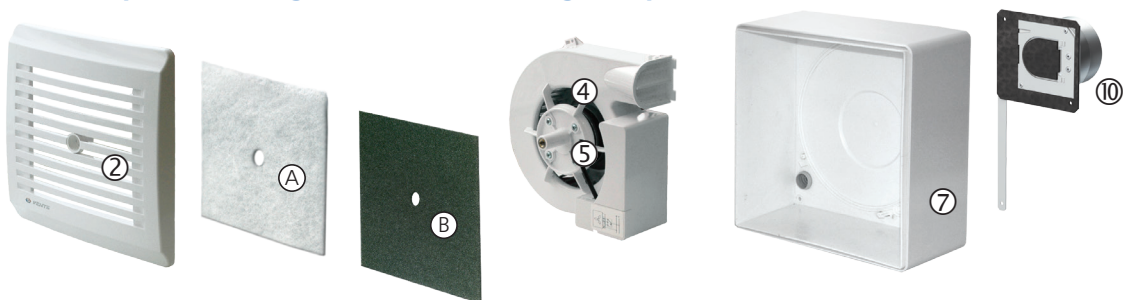

- ⑧ Airtight backdraft damper**
 The backdraft damper is incorporated into the plastic casing to disable air back draft from the main shaft into premises when the fan is not running. During the fan operation air is exhausted directly into the main shaft.
- ⑨ Fireproof casing for flush mounting to wall**
 Designed to prevent penetration of flame products into the premises in case of fire. Made of silicate plates manufactured by special calcium silicate technology. The plates contain no asbestos and have high mechanical and insulation properties. High hygroscopic and vapor permeable features provide humidity regulation by the material itself. High fire-resisting characteristics of the casing let the fan meet the increased fire safety requirements and enable the fan use for high-rise construction.
- ⑩ Fire-retarding damper**
 Serves to prevent fire and smoke penetration along the air ducts. As the temperature in the shaft reaches 90°C the thermal fuse melts and the damper shuts automatically hot air access off. This way the flame and smoke penetration through the ventilation shaft system is prevented. The damper plate is made of stainless steel. The fire-retarding damper serves as a backdraft damper when the fan is off and prevents air moving from the ventilation shaft.

VNV-1 80



Ventilation unit for exhaust ventilation with air capacity up to 150 m³/h

Application

- Exhaust ventilation of high-rise residential and non-residential premises.
- Suitable for premises with mono-pipe ventilation system.
- Mounting in kitchens, bathrooms, toilets, storerooms and other household rooms.
- Installed into the plastic or fireproof casing.
- For periodic or continuous operation.

Options for 2 speed fan models



T – timer modification:

The fan is switched on to the maximum speed manually with the external switch, turn-on delay time is 50 seconds. The return to default position is performed with the timer, run-out time is 6 minutes. Continuous low speed operation is possible.



TR – adjustable timer modification:

The fan can be switched to the maximum speed manually with the external switch. Turn-on delay time is set with the internal regulator ranging from 0 to 150 seconds. Run-out time is set with the internal regulator from 2 to 30 minutes. Continuous low speed operation is possible.



I – interval switch modification:

The fan switches periodically to the maximum speed while operation. The switching interval is set by means of the internal regulator ranging between 0.5 and 15 hours. Run-out time is 10 minutes. The fan can be switched manually with the external switch, turn-on delay time is 50 seconds. Continuous low speed operation is possible.

Design

- The front panel is made of high quality and durable ABS plastic.
- Equipped with a polyether filter for motor and impeller protection against dust and dirt penetration (G4 filter class).
- The turnable front panel conceals possible inaccuracies of the fan casing installation.
- Fastened to the casing by means of latches and requires no tools.
- The impeller design provides increase of the fan efficiency and the motor service life.

Motor

- Energy efficient 2- or 3-speed motor with minimum energy demand.
- Automatic maintaining of constant pressure and air flow in the duct.
- Ball bearings increase the motor service life.
- For precise characteristics, low noise level and safe operation each turbine is dynamically balanced while assembly.

Modifications and options

- VNV-1 80 T** – fan with timer.
- VNV-1 80 TR** – fan with regulated timer.
- VNV-1 80 I** – fan with interval switch.
- VNV-1 80 F** – fan with photosensor.
- VNV-1 80 H** – fan with humidity sensor.
- VNV-2 80** – fan with front panel from ground aluminium.
- VNV-2 80 Chrome** – fan with front panel from mirror finish aluminium.
- VNV-2 80 Gold** – fan with front panel from golden mirror finish aluminium.

Control

- Speed switching with the external manual switch. P3-1-300 switch for the three speed fan models and P2-1-300 for the two speed fan models. The speed switches are not included into the delivery set and are available upon order.



The grille fixation to the fan while mounting provides regulation of the front panel rotation angle with respect to the casing to conceal possible mounting inaccuracies.

Order code

VNV-	front panel	air flow [m ³ /h]	80	extra modifications*	front panel colour
	1 - plastic	- 60/100/150		T	- white
	2 - aluminium	A - 35/60		TR	Chrome
		B - 35/100		I	Gold
		C - 35/60/100		F	
		D - 60/100		H	

* for 2 speed fan models only



F – built-in photosensor modification:

The fan switches to the maximum speed after turning-on the light in the room, turn-on delay time is 50 seconds. After decrease of illumination level below the set threshold the fan switches to the run-out operation mode with the duration from 2 to 30 minutes set by the internal regulator. Continuous low speed operation is possible.



H – humidity sensor modification:

The fan switches to the maximum speed as relative humidity level in the room increases. It switches off as relative humidity level drops by 10 % below the set level. The humidity threshold is adjusted in the range between 60 % and 90 %. Force switching to the maximum speed is provided, in this case the turn-on delay time is 50 seconds, and the run-out time is set by the internal regulator between 2 and 30 minutes. Continuous low speed operation is possible.

Accessories

Replaceable filter



SF VNV G4

Speed switch



Fireproof casing



Plastic casing



Accessories description and list see on p. 12,13,24.

Aerodynamic characteristics

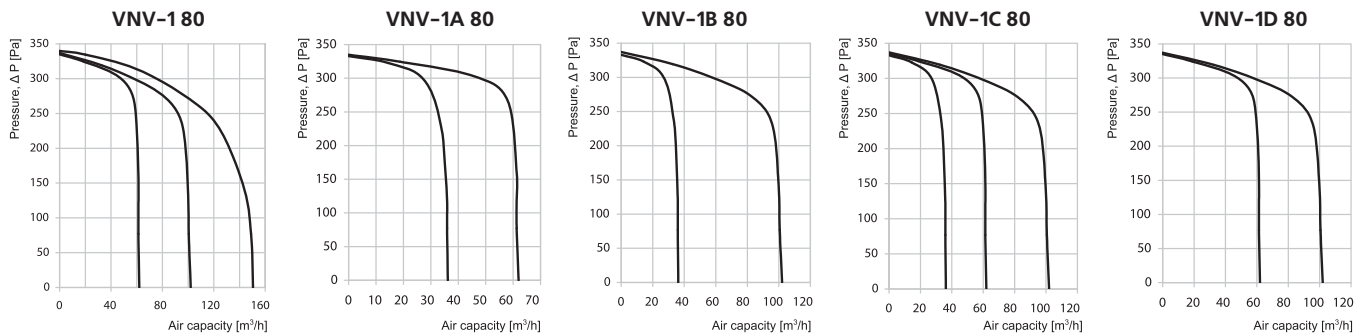

Technical characteristics

Model	VNV-1 80	VNV-1A 80	VNV-1B 80	VNV-1C 80	VNV-1D 80
Number of speeds	3	2	2	3	2
Voltage 50 Hz [V]	220-240	220-240	220-240	220-240	220-240
Power consumption [W]	17/27/48	12/17	12/27	12/17/27	17/27
Current [A]	0,14/0,18/0,21	0,12/0,14	0,12/0,18	0,12/0,14/0,18	0,14/0,18
Connection to power supply network [mm ²]	4x1,5	3x1,5	3x1,5	4x1,5	3x1,5
Maximum air flow [m ³ /h]	63/102/150	35/63	35/102	35/63/102	63/102
Rotation speed [min ⁻¹]	1350/1830/2640	890/1350	890/1830	890/1350/1830	1350/1830
Sound pressure level at 3 m distance [dBA]	30/35,2/43,7	26,6/30	26,6/35,2	26,6/30/35,2	30/35,2
Maximum operating temperature [°C]	50	50	50	50	50

The abrupt curves show high pressure performance of VNV fans and constant air flow while operation of many fans integrated into single ventilation shaft:

- available pressure up to 270 Pa at 35 m³/h;
- available pressure up to 260 Pa at 60 m³/h;
- available pressure up to 220 Pa at 100 m³/h.

Front panel modifications



Overall dimensions

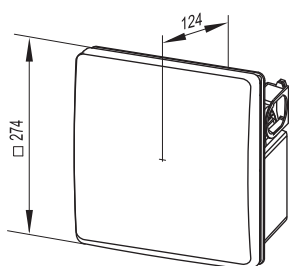

Mounting example



The fan casing is mounted during construction works and connected to the main ventilation shaft.. Electric wiring for connection of the VNV-1 80 ventilation unit is led out through a special hole in the casing. The front panel is covered with the protective cardboard plate supplied with the unit to avoid damages or contamination during finishing works in the room. After finishing the works the protective cardboard plate is removed and the VNV-1 80 ventilation unit is installed into the casing and connected to the wiring.

Certificates



The fans meet safety norms and standards and electromagnetic compatibility directives.

KP 80



Fireproof casing for ventilation unit VNV-180

Application

- Exhaust ventilation of multi-storey residential and public premises with high fire safety requirements.
- Casing for ventilation unit VNV-180.
- Suitable for premises with mono-pipe ventilation system.
- Mounting in kitchens, bathrooms, toilets, storerooms and other household areas.

Design

- Designed to prevent penetration of flame products through ventilation shafts into the premises in case of fire.
- Fire resistance rating is E90/160.
- Equipped with a maintenance-free fire-retarding damper and fireproof casing.
- Made of silicate plates manufactured by special cement technology based on calcium silicate.
- The plates contain no asbestos and have high mechanical and insulation properties. High hygroscopic and vapor permeable features provide humidity regulation by the material itself.
- Installed into a wall during construction works.
- Connected with the main ventilation shaft with a flexible air duct.
- Connecting branch pipe diameter 80 mm.
- The ventilation unit is fastened to the casing by means of latches with no tools.
- Supplied with the protective cardboard plate to protect the casing from dirt and dust penetration during construction and finishing works in the room.

Modifications and options

- In case of two-room ventilation system the casing is equipped with extra branch pipes with three air duct layout modifications for adjacent room ventilation. In such a case the kit for exhaust ventilation of the adjacent room is used.

Fire damper

- Prevents smoke and fire propagation through the air ducts in case of fire.
- As the temperature in the shaft reaches 90°C the thermal fuse melts and the damper shuts automatically hot air access off, so the flame and smoke penetration through the ventilation shaft system is prevented.
- The damper plate is made of stainless steel.
- Operates as a backdraft damper when the fan is off and prevents air flow from the ventilation shaft.

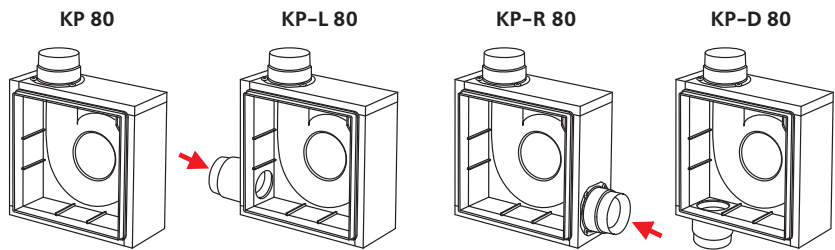

➔ Air duct connection for adjacent room ventilation: on the left (KP-L 80), on the right (KP-R 80), on the bottom (KP-D 80)

Overall dimensions

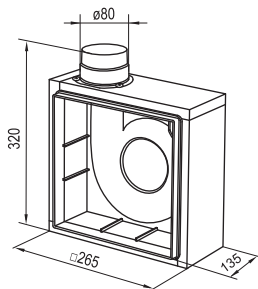

Mounting example



Order code

KP extra branch pipe 80
 - no extra branch pipe
 -L - on the left
 -R - on the right
 -D - on the bottom

Accessories



Accessories description and list see on p. 24

KV 80



Plastic casing for VNV-180 ventilation unit

KVK 80



Plastic casing with fire-retarding damper for ventilation unit VNV-180



Attention!!!
While installing the fan casing make sure of the correct backdraft damper position. It must close automatically under the gravity force when the system is off.

Application

- Casings for the ventilation unit VNV-180.
- Suitable for premises with mono-pipe ventilation system.
- Mounting in kitchens, bathrooms, toilets, storerooms and other household areas.

KV 80 Design

- Installed into a wall during construction works.
- No fire-proof functions.
- Made of high-quality durable ABS plastic.
- Equipped with the plastic backdraft damper.
- Connected with the main ventilation shaft with a flexible air duct.
- Connecting branch pipe diameter 80 mm.
- Supplied with the protective cardboard plate to protect the casing from dirt and dust penetration during construction and finishing works in the room.
- The case perforations allow connecting extra branch pipes for adjacent room ventilation. In this case a kit for exhaust ventilation of adjacent room is used. To connect an extra branch pipe remove the plug in the casing.

KVK 80 Design

- Installed into a wall during construction works.
- Equipped with maintenance-free fire-retarding damper to prevent fire and smoke penetration along the air ducts.
- As the temperature in the shaft reaches 90°C the thermal fuse melts and the damper shuts automatically hot air access off, so the flame and smoke penetration through the ventilation shaft system is prevented.
- The fire-retarding damper serves as a backdraft damper when the fan is off and prevents air moving from the ventilation shaft.
- Made of high-quality durable ABS plastic.
- Connected to the main ventilation shaft with a flexible air duct.
- Connecting branch pipe diameter 80 mm.
- Supplied with the protective cardboard plate to protect the casing from dirt and dust penetration during construction and finishing works in the room.
- In case of adjacent room ventilation system the casing is equipped with extra branch pipes with three air duct layout modifications for adjacent room ventilation. In such a case the kit for exhaust ventilation of adjacent room is used.

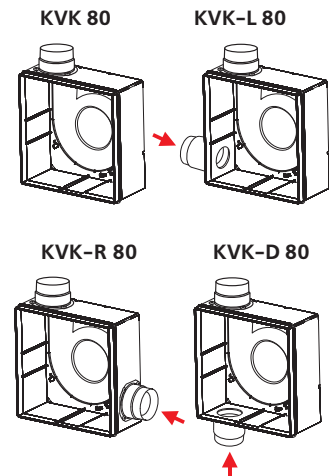
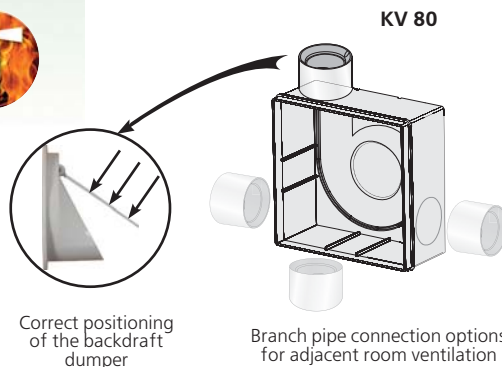

Mounting example



Overall dimensions KV 80

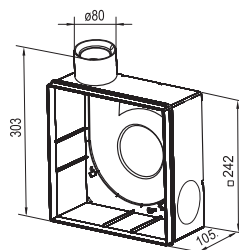

Overall dimensions KVK 80

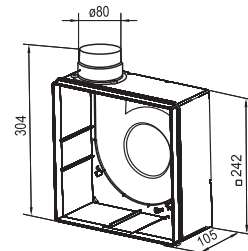

Order code

KV	fireproof branch pipe	extra fireproof branch pipe	280
	K	- no extra branch pipe -L - on the left -R - on the right -D - on the bottom	

Accessories



VNV-1 80 KP



Centrifugal fan in fireproof casing with air capacity up to 150 m³/h

Application

- Exhaust ventilation of high-rise residential and non-residential premises with increased fire prevention requirements.
- Suitable for premises with mono-pipe ventilation system.
- Mounting in kitchens, bathrooms, toilets, storerooms and other household areas.

Design

- Supplied in fireproof casing KP 80 for flush mounting to wall (for detailed description and casing mounting procedure refer page 12).
- Equipped with a maintenance-free fire-retarding damper. As the temperature in the shaft reaches 90°C the thermal fuse melts and the damper shuts automatically hot air access off, so the flame and smoke penetration through the ventilation shaft system is prevented.
- The fire-retarding damper serves as a backdraft damper when the fan is off and prevents air moving from the ventilation shaft.
- The front panel is made of high-quality durable ABS plastic.
- The turnable front panel conceals possible inaccuracies of the fan casing installation.

Motor

- Energy efficient 2- or 3-speed motor on ball bearings with minimum energy demand.
- Automatic maintaining of constant pressure and air flow in the duct.
- Fastened to the casing by means of latches with no tools.
- For precise characteristics, low noise level and safe operation each turbine is dynamically balanced while assembly.

Modifications and options

- VNV-1 80 KP T** – fan with timer.
- VNV-1 80 KP TR** – fan with regulated timer.
- VNV-1 80 KP I** – fan with interval switch.
- VNV-1 80 KP F** – fan with photosensor.
- VNV-1 80 KP H** – fan with humidity sensor.
- VNV-2 80** – fan with front panel from ground aluminium.
- VNV-2 80 Chrome** – fan with front panel from mirror finish aluminium.
- VNV-2 80 Gold** – fan with front panel from golden mirror finish aluminium.
- In case of second room ventilation system the casing is equipped with extra branch pipes with three air duct layout modifications for adjacent room ventilation. In such a case the kit for exhaust ventilation of the adjacent room is used.
- VNV-1 80 KP-R** – fan with extra branch pipe on the right.
- VNV-1 80 KP-L** – fan with extra branch pipe on the left.
- VNV-1 80 KP-D** – fan with extra branch pipe on the bottom.

Control

- Speed switch is performed with the external manual speed switch. P3-1-300 switch for the three speed fan models and P2-1-300 for the two speed fan models. The speed switches are not included into the delivery set and are available upon order.

Options for 2 speed fan models



T – timer modification:

The fan is switched on to the maximum speed manually with the external switch, turn-on delay time is 50 seconds. The return to default position is performed with the timer, run-out time is 6 minutes. Continuous low speed operation is possible.



TR – adjustable timer modification:

The fan can be switched to the maximum speed manually with the external switch. Turn-on delay time is set with the internal regulator ranging from 0 to 150 seconds. Run-out time is set with the internal regulator from 2 to 30 minutes. Continuous low speed operation is possible.



I – interval switch modification:

The fan switches periodically to the maximum speed while operation. The switching interval is set by means of the internal regulator ranging between 0.5 and 15 hours. Run-out time is 10 minutes. The fan can be switched manually with the external switch, turn-on delay time is 50 seconds. Continuous low speed operation is possible.



F – built-in photosensor modification:

The fan switches to the maximum speed after turning-on the light in the room, turn-on delay time is 50 seconds. After decrease of illumination level below the set threshold the fan switches to the run-out operation mode with the duration from 2 to 30 minutes set by the internal regulator. Continuous low speed operation is possible.



H – humidity sensor modification:

The fan switches to the maximum speed as relative humidity level in the room increases. It switches off as relative humidity level drops by 10 % below the set level. The humidity threshold is adjusted in the range between 60 % and 90 %. Force switching to the maximum speed is provided, in this case the turn-on delay time is 50 seconds, and the run-out time is set by the internal regulator between 2 and 30 minutes. Continuous low speed operation is possible.

Order code

VNV-	front panel	air flow [m ³ /h]	80 KP	extra branch pipe	extra modifications*	front panel colour
	1 - plastic	- 60/100/150		- no extra	T	- white
	2 - aluminium	A - 35/60		branch pipe	TR	Chrome
		B - 35/100		-L - on the left	I	Gold
		C - 35/60/100		-R - on the right	F	
		D - 60/100		-D - on the bottom	H	

* for 2 speed fan models only

Accessories

Filter Speed switch Bracket Thermovent Clamps



Accessories description and list see on p. 24

Aerodynamic characteristics

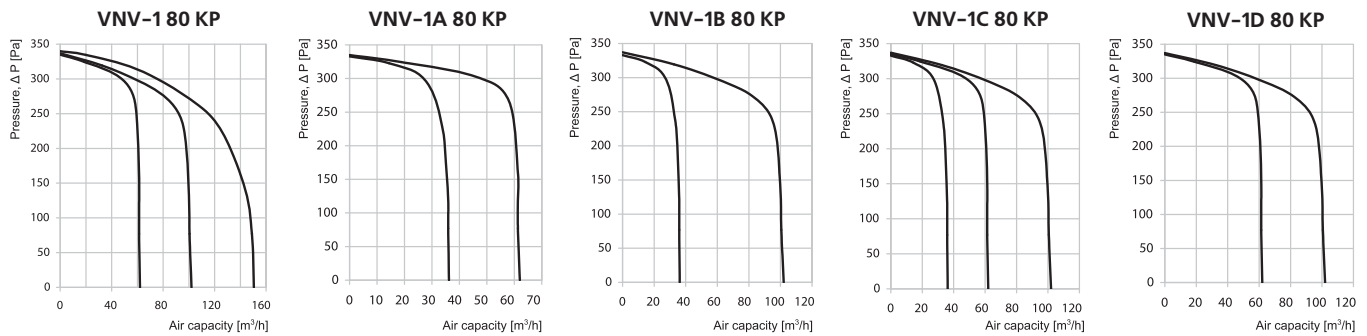

The abrupt curves show high pressure performance of VNV fans and constant air flow while operation of many fans integrated into single ventilation shaft:

- available pressure up to 270 Pa at 35 m³/h;
- available pressure up to 260 Pa at 60 m³/h;
- available pressure up to 220 Pa at 100 m³/h.

Technical characteristics

Model	VNV-1 80 KP	VNV-1A 80 KP	VNV-1B 80 KP	VNV-1C 80 KP	VNV-1D 80 KP
Number of speeds	3	2	2	3	2
Voltage 50 Hz [V]	220-240	220-240	220-240	220-240	220-240
Power consumption [W]	17/27/48	12/17	12/27	12/17/27	17/27
Current [A]	0,14/0,18/0,21	0,12/0,14	0,12/0,18	0,12/0,14/0,18	0,14/0,18
Connection to power supply network [mm ²]	4x1,5	3x1,5	3x1,5	4x1,5	3x1,5
Maximum air flow [m ³ /h]	63/102/150	35/63	35/102	35/63/102	63/102
Rotation speed [min ⁻¹]	1350/1830/2640	890/1350	890/1830	890/1350/1830	1350/1830
Sound pressure level at 3 m distance [dBA]	30/35,2/43,7	26,6/30	26,6/35,2	26,6/30/35,2	30/35,2
Maximum operating temperature [°C]	50	50	50	50	50

Front panel modifications

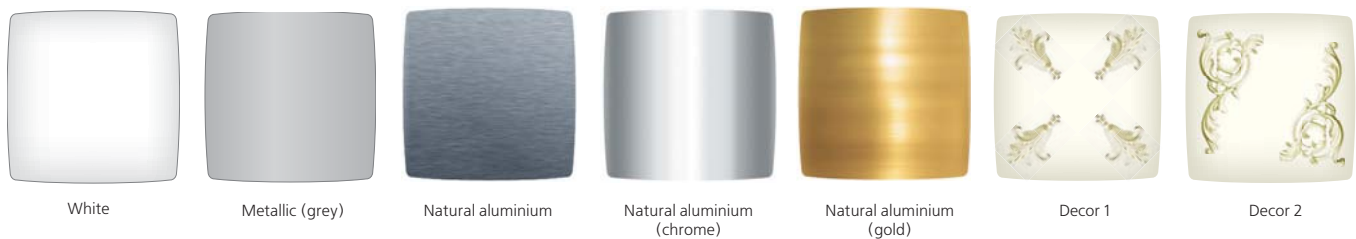

Overall dimensions

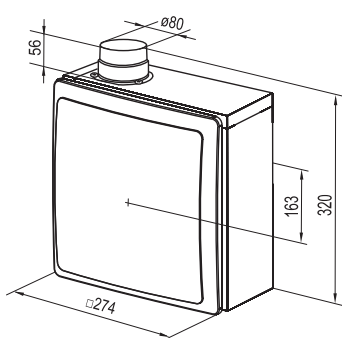

Mounting example



The fan casing is mounted during construction works and connected to the main ventilation shaft. Electric wiring for connection of the VNV-1 80 ventilation unit is led out through a special hole in the casing. The front panel is covered with the protective cardboard plate supplied with the unit to avoid damages or contamination during finishing works in the room. After finishing the works the protective cardboard plate is removed and the VNV-1 80 ventilation unit is installed into the casing that is connected to the wiring.

Certificates



The fans meet safety norms and standards and electromagnetic compatibility directives.

VNV-1 80 KV



Centrifugal fan
in plastic casing with
air capacity up to 150 m³/h

Application

- Suitable for premises with mono-pipe ventilation system.
- Mounting in kitchens, bathrooms, toilets, storerooms and other household areas.

Design

- Supplied in plastic casing KV 80 for flush mounting to wall (for detailed description and casing mounting procedure refer page 13).
- The front panel is made of high-quality durable ABS plastic.
- Equipped with a plastic backdraft damper.
- The turnable front panel conceals possible inaccuracies of the fan casing installation.
- Connected with the main ventilation shaft with a flexible air duct.
- Connecting branch pipe diameter 80 mm.

Motor

- Energy efficient 2- or 3-speed motor on ball bearings with minimum energy demand.
- Automatic maintaining of constant pressure and air flow in the duct.
- Fastened to the casing by means of latches with no tools.
- For precise characteristics, low noise level and safe operation each turbine is dynamically balanced while assembly.

Modifications and options

- VNV-1 80 KV T** – fan with timer.
- VNV-1 80 KV TR** – fan with regulated timer.
- VNV-1 80 KV I** – fan with interval switch.
- VNV-1 80 KV F** – fan with photosensor.
- VNV-1 80 KV H** – fan with humidity sensor.
- VNV-2 80 KV** – fan with front panel from ground aluminium.
- VNV-2 80 KV Chrome** – fan with front panel from mirror finish aluminium.
- VNV-2 80 KV Gold** – fan with front panel from golden mirror finish aluminium.

- The case perforations allow connecting extra branch pipes for second room ventilation system. In case of second room ventilation system the casing is perforated for extra branch pipes for exhaust ventilation of the adjacent room. Remove a plug in the casing to connect extra branch pipe.

Control

- Speed switch by means of the external manual switch. P3-1-300 speed switch for the three speed fan models and P2-1-300 for the two speed fan models. The speed switches are not included into the delivery set and are available upon order.

Options for 2 speed fan models



T – timer modification:

The fan is switched on to the maximum speed manually with the external switch, turn-on delay time is 50 seconds. The return to default position is performed with the timer, run-out time is 6 minutes. Continuous low speed operation is possible.



TR – adjustable timer modification:

The fan can be switched to the maximum speed manually with the external switch. Turn-on delay time is set with the internal regulator ranging from 0 to 150 seconds. Run-out time is set with the internal regulator from 2 to 30 minutes. Continuous low speed operation is possible.



I – interval switch modification:

The fan switches periodically to the maximum speed while operation. The switching interval is set by means of the internal regulator ranging between 0.5 and 15 hours. Run-out time is 10 minutes. The fan can be switched manually with the external switch, turn-on delay time is 50 seconds. Continuous low speed operation is possible.



F – built-in photosensor modification:

The fan switches to the maximum speed after turning-on the light in the room, turn-on delay time is 50 seconds. After decrease of illumination level below the set threshold the fan switches to the run-out operation mode with the duration from 2 to 30 minutes set by the internal regulator. Continuous low speed operation is possible.



H – humidity sensor modification:

The fan switches to the maximum speed as relative humidity level in the room increases. It switches off as relative humidity level drops by 10 % below the set level. The humidity threshold is adjusted in the range between 60 % and 90 %. Force switching to the maximum speed is provided, in this case the turn-on delay time is 50 seconds, and the run-out time is set by the internal regulator between 2 and 30 minutes. Continuous low speed operation is possible.

Order code

VNV-	front panel	air flow [m ³ /h]	80 KV	extra modifications*	front panel colour
	1 - plastic 2 - aluminium	- 60/100/150 A - 35/60 B - 35/100 C - 35/60/100 D - 60/100		T TR I F H	- white Chrome Gold

* for 2 speed fan models only

Accessories

Filter Speed switch Bracket Aluvent Clamps



Accessories description and list see on p. 24

Aerodynamic characteristics

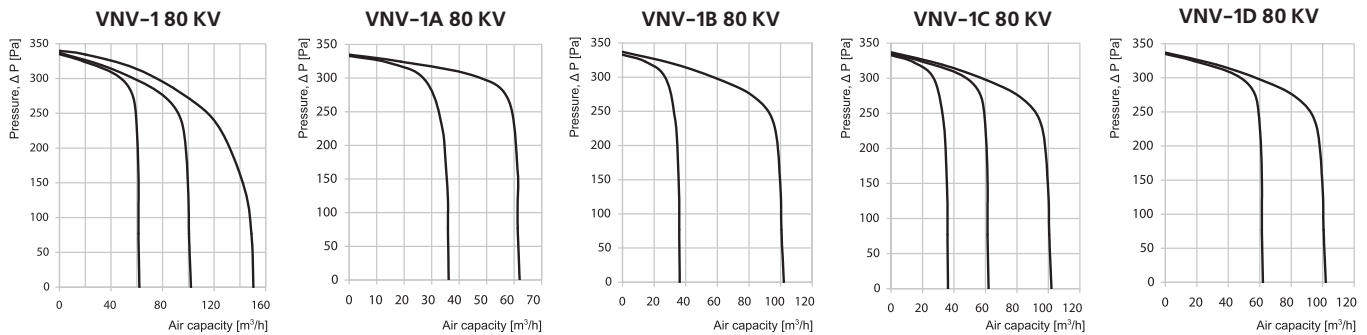

The abrupt curves show high pressure performance of VNV fans and constant air flow while operation of many fans integrated into single ventilation shaft:

- available pressure up to 270 Pa at 35 m³/h;
- available pressure up to 260 Pa at 60 m³/h;
- available pressure up to 220 Pa at 100 m³/h.

Technical characteristics

Model	VNV-1 80 KV	VNV-1A 80 KV	VNV-1B 80 KV	VNV-1C 80 KV	VNV-1D 80 KV
Number of speeds	3	2	2	3	2
Voltage 50 Hz [V]	220-240	220-240	220-240	220-240	220-240
Power consumption [W]	17/27/48	12/17	12/27	12/17/27	17/27
Current [A]	0,14/0,18/0,21	0,12/0,14	0,12/0,18	0,12/0,14/0,18	0,14/0,18
Connection to power supply network [mm ²]	4x1,5	3x1,5	3x1,5	4x1,5	3x1,5
Maximum air flow [m ³ /h]	63/102/150	35/63	35/102	35/63/102	63/102
Rotation speed [min ⁻¹]	1350/1830/2640	890/1350	890/1830	890/1350/1830	1350/1830
Sound pressure level at 3 m distance [dBA]	30/35,2/43,7	26,6/30	26,6/35,2	26,6/30/35,2	30/35,2
Maximum operating temperature [°C]	50	50	50	50	50

Front panel modifications



Overall dimensions

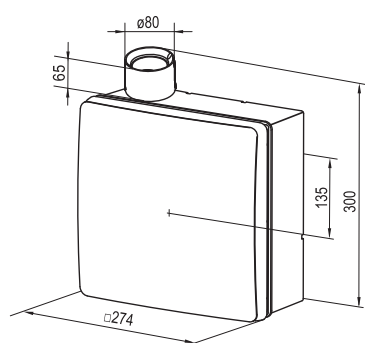

Mounting example

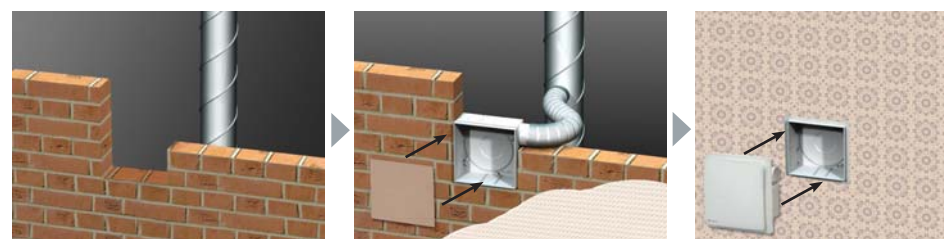

The fan casing is mounted during construction works and connected to the main ventilation shaft.. Electric wiring for connection of the VNV-1 80 ventilation unit is routed through a special hole in the casing. The front panel is covered with the protective cardboard plate supplied with the unit to avoid damages or contamination during finishing works in the room. After finishing the repair works the protective cardboard plate is removed and the VNV-1 80 ventilation unit is installed into the casing and connected to the wiring.

Certificates



The fans meet safety norms and standards and electromagnetic compatibility directives.

VNV-1 80 KVK



Centrifugal fan in plastic casing with fire-retarding damper and air capacity up to 150 m³/h

Application

- Exhaust ventilation of high-rise residential and non-residential premises with increased fire prevention requirements.
- Suitable for premises with mono-pipe ventilation system.
- Mounting in kitchens, bathrooms, toilets, storerooms and other household areas.

Design

- Supplied in plastic casing KVK 80 for flush mounting to wall (for detailed description and casing mounting procedure refer page 13).
- The front panel is made of high-quality durable ABS plastic.
- Equipped with maintenance-free fire-retarding damper. As the temperature in the shaft reaches 90°C the thermal fuse melts and the damper shuts automatically hot air access off, so the flame and smoke penetration through the ventilation shaft system is prevented.
- The fire-retarding damper serves as a backdraft damper when the fan is off and prevents air moving from the ventilation shaft.
- The turnable front panel conceals possible inaccuracies of the fan casing installation.
- Connected with the main ventilation shaft with a flexible air duct.
- Connecting branch pipe diameter 80 mm.

Motor

- Energy efficient 2- or 3-speed motor on ball bearings with minimum energy demand.
- Automatic maintaining of constant pressure and air flow in the duct.
- Fastened to the casing by means of latches with no tools.
- For precise characteristics, low noise level and safe operation each turbine is dynamically balanced while assembly.

Modifications and options

- VNV-1 80 KVK T** – fan with timer.
- VNV-1 80 KVK TP** – fan with regulated timer.
- VNV-1 80 KVK I** – fan with interval switch.
- VNV-1 80 KVK F** – fan with photosensor.
- VNV-1 80 KVK H** – fan with humidity sensor.
- VNV-2 80 KVK** – fan with front panel from ground aluminium.
- VNV-2 80 KVK Chrome** – fan with front panel from mirror finish aluminium.
- VNV-2 80 KVK Gold** – fan with front panel from golden mirror finish aluminium.
- In case of second room ventilation system the casing is equipped with extra branch pipes with three air duct layout modifications for adjacent room ventilation. In such a case the kit for exhaust ventilation of the adjacent room is used.

Control

- Speed switch is performed with the external manual switch. P3-1-300 speed switch for the three speed fan models and P2-1-300 for the two speed fan models. The speed switches are not included into the delivery set and are available upon order.

Options for 2 speed fan models



T – timer modification:

The fan is switched on to the maximum speed manually with the external switch, turn-on delay time is 50 seconds. The return to default position is performed with the timer, run-out time is 6 minutes. Continuous low speed operation is possible.



TR – adjustable timer modification:

The fan can be switched to the maximum speed manually with the external switch. Turn-on delay time is set with the internal regulator ranging from 0 to 150 seconds. Run-out time is set with the internal regulator from 2 to 30 minutes. Continuous low speed operation is possible.



I – interval switch modification:

The fan switches periodically to the maximum speed while operation. The switching interval is set by means of the internal regulator ranging between 0.5 and 15 hours. Run-out time is 10 minutes. The fan can be switched manually with the external switch, turn-on delay time is 50 seconds. Continuous low speed operation is possible.



F – built-in photosensor modification:

The fan switches to the maximum speed after turning-on the light in the room, turn-on delay time is 50 seconds. After decrease of illumination level below the set threshold the fan switches to the run-out operation mode with the duration from 2 to 30 minutes set by the internal regulator. Continuous low speed operation is possible.



H – humidity sensor modification:

The fan switches to the maximum speed as relative humidity level in the room increases. It switches off as relative humidity level drops by 10 % below the set level. The humidity threshold is adjusted in the range between 60 % and 90 %. Force switching to the maximum speed is provided, in this case the turn-on delay time is 50 seconds, and the run-out time is set by the internal regulator between 2 and 30 minutes. Continuous low speed operation is possible.

Order code

VNV-	front panel	air flow [m ³ /h]	80 KVK	extra modifications*	front panel colour
1	plastic	- 60/100/150		T	- white
2	aluminium	A - 35/60		TR	Chrome
		B - 35/100		I	Gold
		C - 35/60/100		F	
		D - 60/100		H	

* for 2 speed fan models only

Accessories

Filter Speed switch Bracket Thermovent Clamps



Accessories description and list see on p. 24

Aerodynamic characteristics

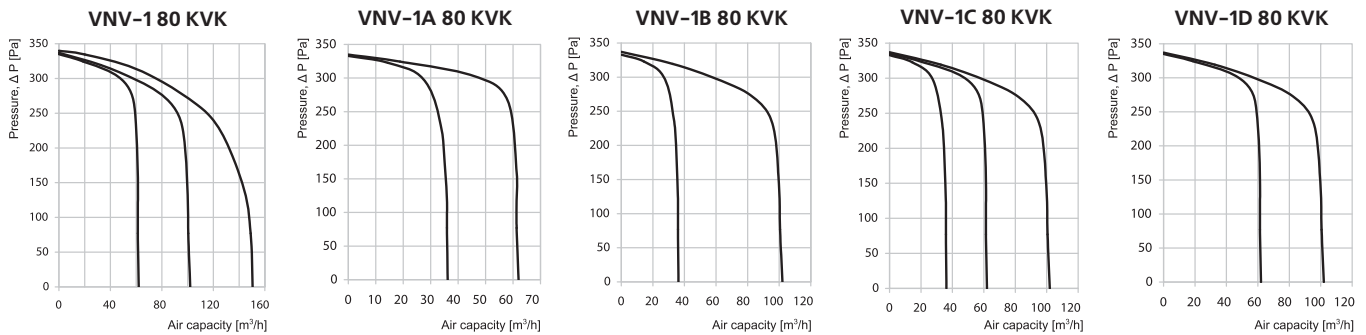

The abrupt curves show high pressure performance of VNV fans and constant air flow while operation of many fans integrated into single ventilation shaft:

- available pressure up to 270 Pa at 35 m³/h;
- available pressure up to 260 Pa at 60 m³/h;
- available pressure up to 220 Pa at 100 m³/h.

Technical characteristics

Model	VNV-1 80 KVK	VNV-1A 80 KVK	VNV-1B 80 KVK	VNV-1C 80 KVK	VNV-1D 80 KVK
Number of speeds	3	2	2	3	2
Voltage 50 Hz [V]	220-240	220-240	220-240	220-240	220-240
Power consumption [W]	17/27/48	12/17	12/27	12/17/27	17/27
Current [A]	0,14/0,18/0,21	0,12/0,14	0,12/0,18	0,12/0,14/0,18	0,14/0,18
Connection to power supply network [mm ²]	4x1,5	3x1,5	3x1,5	4x1,5	3x1,5
Maximum air flow [m ³ /h]	63/102/150	35/63	35/102	35/63/102	63/102
Rotation speed [min ⁻¹]	1350/1830/2640	890/1350	890/1830	890/1350/1830	1350/1830
Sound pressure level at 3 m distance [dBA]	30/35,2/43,7	26,6/30	26,6/35,2	26,6/30/35,2	30/35,2
Maximum operating temperature [°C]	50	50	50	50	50

Front panel modifications



Overall dimensions

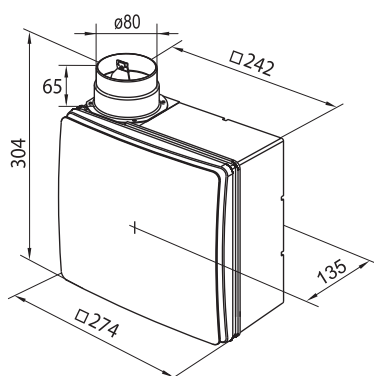

Mounting example

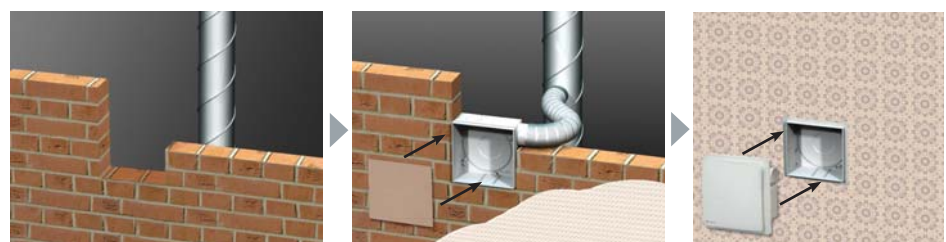

The fan casing is mounted during construction works and connected to the main ventilation shaft. Electric wiring for connection of the VNV-1 80 ventilation unit is led out through a special hole in the casing. The front panel is covered with the protective cardboard plate supplied with the unit to avoid damages or contamination during finishing works in the room. After finishing the works the protective cardboard plate is removed and the VNV-1 80 ventilation unit is installed into the casing that is connected to the wiring.

Certificates



The fans meet safety norms and standards and electromagnetic compatibility directives.

VN-1 80



VN 80



Centrifugal fans in plastic casing with fire-retarding damper and air capacity up to 150 m³/h

Application

- Suitable for premises with mono-pipe ventilation system.
- Mounting in kitchens, bathrooms, toilets, storerooms and other household areas.

Design

- For wall surface mounting.
- The front panel and the casing are made of high-quality durable ABS plastic.
- Equipped with the plastic backdraft damper.
- Connected with the main ventilation shaft with a flexible air duct.
- Connecting branch pipe diameter 80 mm.

Motor

- Energy efficient 2- or 3-speed motor on ball bearings with minimum energy demand.
- Automatic maintaining of constant pressure and air flow in the duct.
- For precise characteristics, low noise level and safe operation each turbine is dynamically balanced while assembly.

Modifications and options

- VN-1 80 T / VN 80 T** – fans with timer.
- VN-1 80 TR / VN 80 TR** – fans with regulated timer.
- VN-1 80 I / VN 80 I** – fans with interval switch.
- VN-1 80 F / VN 80 F** – fans with photosensor.
- VN-1 80 H / VN 80 H** – fans with humidity sensor.
- VN-2 80** – fan with front panel from ground aluminium.
- VN-2 80 Chrome** – fan with front panel from mirror finish aluminium.
- VN-2 80 Gold** – fan with front panel from golden mirror finish aluminium.

Control

- Speed switch is performed with the external manual switch. P3-1-300 speed switch for the three speed fan models and P2-1-300 for the two speed fan models. The speed switches are not included into the delivery set and are available upon order.

Options for 2 speed fan models



T – timer modification:

The fan is switched on to the maximum speed manually with the external switch, turn-on delay time is 50 seconds. The return to default position is performed with the timer, run-out time is 6 minutes. Continuous low speed operation is possible.



TR – adjustable timer modification:

The fan can be switched to the maximum speed manually with the external switch. Turn-on delay time is set with the internal regulator ranging from 0 to 150 seconds. Run-out time is set with the internal regulator from 2 to 30 minutes. Continuous low speed operation is possible.



I – interval switch modification:

The fan switches periodically to the maximum speed while operation. The switching interval is set by means of the internal regulator ranging between 0.5 and 15 hours. Run-out time is 10 minutes. The fan can be switched manually with the external switch, turn-on delay time is 50 seconds. Continuous low speed operation is possible.



F – built-in photosensor modification:

The fan switches to the maximum speed after turning-on the light in the room, turn-on delay time is 50 seconds. After decrease of illumination level below the set threshold the fan switches to the run-out operation mode with the duration from 2 to 30 minutes set by the internal regulator. Continuous low speed operation is possible.



H – humidity sensor modification:

The fan switches to the maximum speed as relative humidity level in the room increases. It switches off as relative humidity level drops by 10 % below the set level. The humidity threshold is adjusted in the range between 60 % and 90 %. Force switching to the maximum speed is provided, in this case the turn-on delay time is 50 seconds, and the run-out time is set by the internal regulator between 2 and 30 minutes. Continuous low speed operation is possible.

Order code

VN-	front panel	air flow [m ³ /h]	80	extra modifications*	front panel colour
-	- grille	- 60/100/150		T	- white
1	plastic front cover	A - 35/60		TR	Chrome
		B - 35/100		I	Gold
2	aluminium front panel	C - 35/60/100		F	
		D - 60/100		H	

* for 2 speed fan models only

Accessories

Filter Speed switch Door grille Thermovent Clamps



Accessories description and list see on p. 24

Aerodynamic characteristics

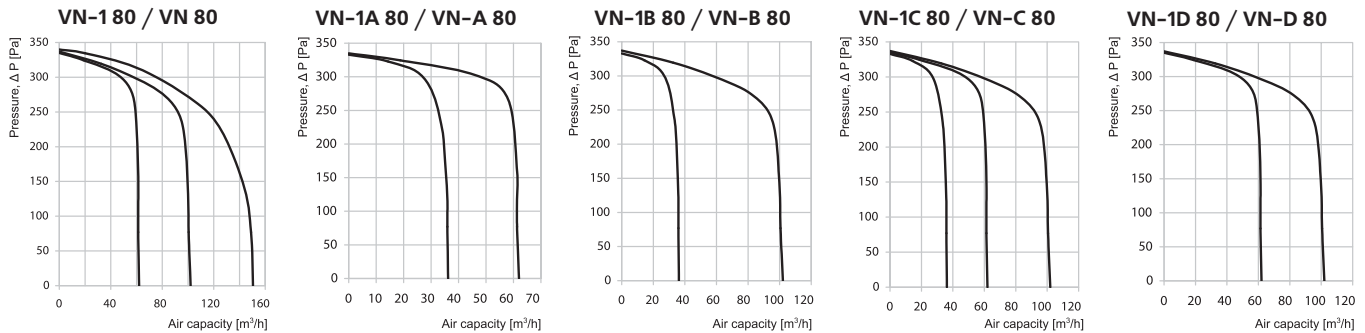

The abrupt curves show high pressure performance of VNV fans and constant air flow while operation of many fans integrated into single ventilation shaft:

- available pressure up to 270 Pa at 35 m³/h;
- available pressure up to 260 Pa at 60 m³/h;
- available pressure up to 220 Pa at 100 m³/h.

Technical characteristics

Model	VN-180 VN 80	VN-1A 80 VN-A 80	VN-1B 80 VN-B 80	VN-1C 80 VN-C 80	VN-1D 80 VN-D 80
Number of speeds	3	2	2	3	2
Voltage 50 Hz [V]	220-240	220-240	220-240	220-240	220-240
Power consumption [W]	17/27/48	12/17	12/27	12/17/27	17/27
Current [A]	0,14/0,18/0,21	0,12/0,14	0,12/0,18	0,12/0,14/0,18	0,14/0,18
Connection to power supply network [mm ²]	4x1,5	3x1,5	3x1,5	4x1,5	3x1,5
Maximum air flow [m ³ /h]	63/102/150	35/63	35/102	35/63/102	63/102
Rotation speed [min ⁻¹]	1350/1830/2640	890/1350	890/1830	890/1350/1830	1350/1830
Sound pressure level at 3 m distance [dBA]	30/35,2/43,7	26,6/30	26,6/35,2	26,6/30/35,2	30/35,2
Maximum operating temperature [°C]	50	50	50	50	50

Front panel modifications*



* For fan VN-180 and its modifications only.

Overall dimensions

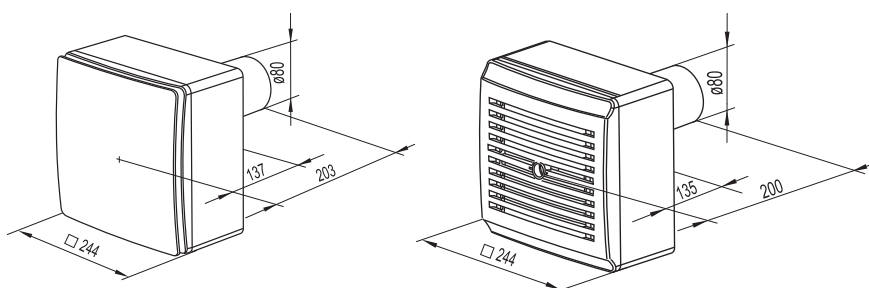

Mounting example

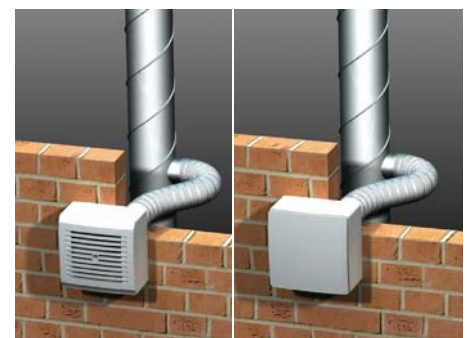

Certificates



The fans meet safety norms and standards and electromagnetic compatibility directives.

VN-1 80 K



VN 80 K



Centrifugal fans in plastic casing with fire-retarding damper and air capacity up to 150 m³/h

Application

- Exhaust ventilation of high-rise residential and non-residential premises with increased fire prevention requirements.
- Exhaust ventilation of high-rise residential and non-residential premises with increased fire prevention requirements.
- Mounting in kitchens, bathrooms, toilets, storerooms and other household areas.

Design

- For wall surface mounting.
- The front panel and the casing are made of high-quality durable ABS plastic.
- Equipped with maintenance-free fire-retarding damper. As the temperature in the shaft reaches 90°C the thermal fuse melts and the damper shuts automatically hot air access off, and the flame and smoke ingress to the room though the ventilation shaft system is prevented.
- For easy mounting the damper is mounted on a pivot rod. First mount the damper to the wall and then fix the fan casing (see mounting examples).
- The fire-retarding damper serves as a backdraft damper when the fan is off and prevents air moving from the ventilation shaft.
- Connected with the main ventilation shaft with a flexible air duct.
- Connecting branch pipe diameter 80 mm.

Motor

- Energy efficient 2- or 3-speed motor on ball bearings with minimum energy demand.
- Automatic maintaining of constant pressure and air flow in the duct.
- For precise characteristics, low noise level and safe operation each turbine is dynamically balanced while assembly.

Modifications and options

- VN-180 K T / VN 80 K T** – fans with timer.
- VN-1 80 K TR / VN 80 K TR** – fans with regulated timer.
- VN-180 K I / VN 80 K I** – fans with interval switch.
- VN-1 80 K F / VN 80 K F** – fans with photosensor.
- VN-180 K H / VN 80 K H** – fans with humidity sensor.
- VN-2 80 K** – fan with front panel from ground aluminium.
- VN-2 80 K Chrome** – fan with front panel from mirror finish aluminium.
- VN-2 80 K Gold** – fan with front panel from golden mirror finish aluminium.

Control

- Speed switch is performed with the external manual switch. P3-1-300 speed switch for the three speed fan models and P2-1-300 for the two speed fan models. The speed switches are not included into the delivery set and are available upon order.

Options for 2 speed fan models



T – timer modification:

The fan is switched on to the maximum speed manually with the external switch, turn-on delay time is 50 seconds. The return to default position is performed with the timer, run-out time is 6 minutes. Continuous low speed operation is possible.



TR – adjustable timer modification:

The fan can be switched to the maximum speed manually with the external switch. Turn-on delay time is set with the internal regulator ranging from 0 to 150 seconds. Run-out time is set with the internal regulator from 2 to 30 minutes. Continuous low speed operation is possible.



I – interval switch modification:

The fan switches periodically to the maximum speed while operation. The switching interval is set by means of the internal regulator ranging between 0.5 and 15 hours. Run-out time is 10 minutes. The fan can be switched manually with the external switch, turn-on delay time is 50 seconds. Continuous low speed operation is possible.



F – built-in photosensor modification:

The fan switches to the maximum speed after turning-on the light in the room, turn-on delay time is 50 seconds. After decrease of illumination level below the set threshold the fan switches to the run-out operation mode with the duration from 2 to 30 minutes set by the internal regulator. Continuous low speed operation is possible.



H – humidity sensor modification:

The fan switches to the maximum speed as relative humidity level in the room increases. It switches off as relative humidity level drops by 10 % below the set level. The humidity threshold is adjusted in the range between 60 % and 90 %. Force switching to the maximum speed is provided, in this case the turn-on delay time is 50 seconds, and the run-out time is set by the internal regulator between 2 and 30 minutes. Continuous low speed operation is possible.

Order code

VN-	front panel	air flow [m ³ /h]	80 VN	extra modifications*	front panel colour
-	grille	-	60/100/150	T	- white
1-	plastic front panel	A-	35/60	TR	Chrome
2-	aluminium front panel	B-	35/100	I	Gold
		C-	35/60/100	F	
		D-	60/100	H	

* for 2 speed fan models only

Accessories

Filter Speed switch Door grille Thermovent Clamps



Accessories description and list see on p. 24

Aerodynamic characteristics

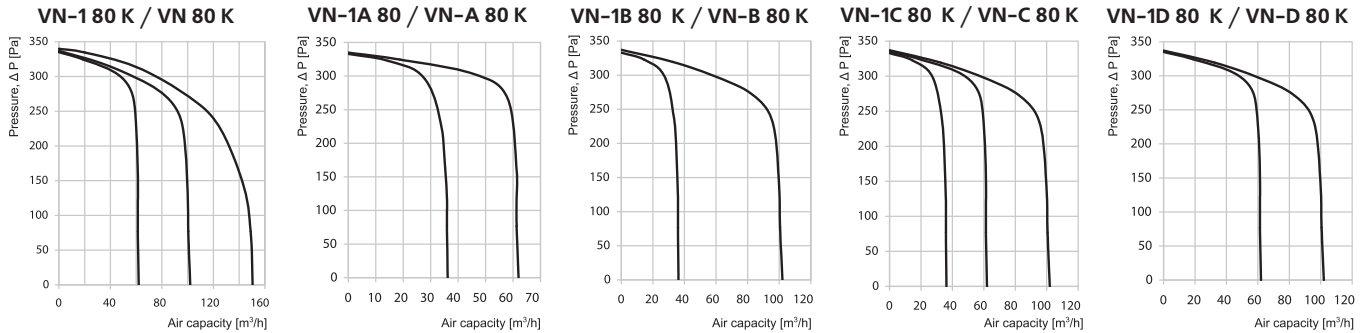

The abrupt curves show high pressure performance of VNV fans and constant air flow while operation of many fans integrated into single ventilation shaft:

- available pressure up to 270 Pa at 35 m³/h;
- available pressure up to 260 Pa at 60 m³/h;
- available pressure up to 220 Pa at 100 m³/h.

Technical characteristics

Model	VN-180 K VN 80 K	VN-1A 80 K VN-A 80 K	VN-1B 80 K VN-B 80 K	VN-1C 80 K VN-C 80 K	VN-1D 80 K VN-D 80 K
Number of speeds	3	2	2	3	2
Voltage 50 Hz [V]	220-240	220-240	220-240	220-240	220-240
Power consumption [W]	17/27/48	12/17	12/27	12/17/27	17/27
Current [A]	0,14/0,18/0,21	0,12/0,14	0,12/0,18	0,12/0,14/0,18	0,14/0,18
Connection to power supply network [mm ²]	4x1,5	3x1,5	3x1,5	4x1,5	3x1,5
Maximum air flow [m ³ /h]	63/102/150	35/63	35/102	35/63/102	63/102
Rotation speed [min ⁻¹]	1350/1830/2640	890/1350	890/1830	890/1350/1830	1350/1830
Sound pressure level at 3 m distance [dBA]	30/35,2/43,7	26,6/30	26,6/35,2	26,6/30/35,2	30/35,2
Maximum operating temperature [°C]	50	50	50	50	50

Front panel modifications



* For fan VN-180 K and its modifications only

Overall dimensions

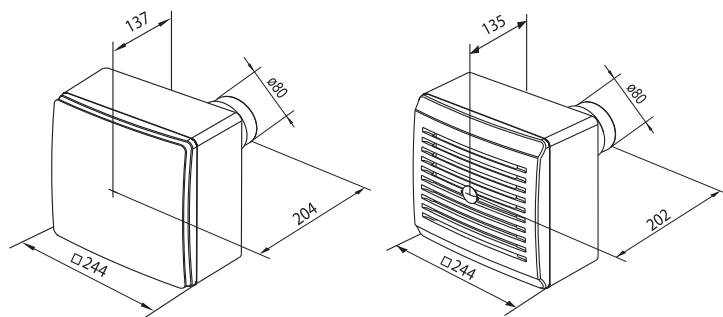

Mounting example

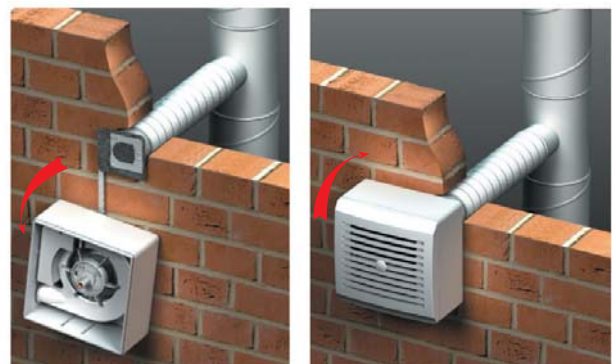

Certificates



The fans meet safety norms and standards and electromagnetic compatibility directives.

Model		Description
	Air ducts Aluvent Ø80	System of flexible air ducts for supply and exhaust ventilation of household and commercial premises. The ducts are made of aluminum tape wound into a spiral and connected with a tight lock. Advantages: low weight, easy to cut with simple tools, increased tightness of seams, increased temperature and chemical resistance.
	Air ducts Thermovent Ø80	System of thermo-resistant flexible air ducts for supply and exhaust ventilation. The air ducts are made of stainless or galvanized steel, have increased thermo- and antirust resistance.
	Spirovent	System of spiral seam tubes for supply and exhaust ventilation. Made of galvanized steel, have increased rigidity.
	Clamp Ø80	For fastening of flexible air ducts to a fan. Made of stainless steel with high corrosion resistance features. Equipped with easy lock made of galvanized steel.
	Speed switches: P2-1-300, P3-1-300	For speed switch and selection of the best operation mode in two-speed fan model (P2-1-300 speed switch) or three-speed fan model (P3-1-300 speed switch).
	Speed switches: P2-5,0 P3-5,0	For speed switch and selection of the best operation mode in two-speed fan model (P2-5.0 speed switch) or three-speed fan model (P3-5.0 speed switch).
	Branch pipe P80	For connecting the air duct from adjacent room to plastic casing KV 80.
	Door ventilation grilles MV	For use in internal residential and commercial premises. Mounted in a door for free air circulation between adjacent rooms. Made of high-quality plastic or metal and are available in different standard sizes and colors.
	Fire damper PL 10	For prevention of smoke and fire propagation through ventilation and air conditioning ducts in case of fire. Mounted in the ventilation ducts laid through fireproof walls and ceilings. Dimension range from Ø 100 to Ø 200 mm.
	Air filter	For protection of the motor and impeller from dust and dirt carried with the air. Filter element is made of polyester. G4 filtering class.
	Window vent PO 400	Sound-insulated passive intake vent for mounting into window frames. High efficient intake of fresh air with closed window. Smooth air flow regulation.
	Wall vent PS 100 PS 101 PS 102	Mechanically regulated intake element for supply ventilation. Mounted into the external wall of a building and provides intake air filtration. The built-in flow regulator allows regulating the intake air volume or closing the ventilation duct completely.
	Plastic reducer 110	For reducing from Ø80 to Ø 100 mm.
	Mounting bracket	For fixing the fans' casings to walls or ceilings. The bracket design provides high reliability and comfortable use. Made with oblong slots for more accurate leveling of the fan casing. Used with KP 80, KV 80 and KVK 80 casings.
	Roof fans VKH VKV	For roof mounting and air exhaust from the ventilation system.
	Kit for adjacent room ventilation	For arranging of exhaust ventilation of two adjacent premises with one fan. Consists of the grille MV 100V, air duct Aluvent 80/3, reducer 110 and branch pipe P80 (for the plastic casing KV 80 only).

Fire damper PL-10



Application

- Fire damper prevents smoke and fire propagation through the air ducts of ventilation and air conditioning systems in case of fire.
- Mounted in the ventilation ducts laid through fireproof walls and ceilings.
- Fire resistance rating is EIS 120.

Design

- Consists of a galvanized steel casing (1), blades from insulation material (calcium silicate) and fireproof material (2), thermic release mechanism (3) activated at 70°C, silicone seal (4) and spring (5).
- The fire damper is open while operation.
- In case of fire the thermoelement melts at 70°C and the spring moves the blade to closed position.

Dimensions

- $D_n = 100, 125, 150, 160, 180, 200$ mm.

Mounting

- Install the fire damper in such a way so that the release mechanism and inspection hole are on the side of the wall or ceiling for easy inspection of the thermic release mechanism and its internal part.
- Building the damper into brick and concrete walls or gypsum plates with the relevant fire resistance rating is allowed.
- To preserve the casing shape during mounting use wooden supports to prevent possible casing deformation and remove them after the final mounting.
- Warning!!! Do not install the fire dampers in high-explosive environment or in ventilation systems designed for exhaust of explosive air-gas mixtures.

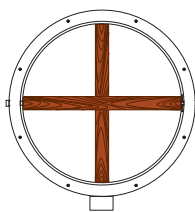
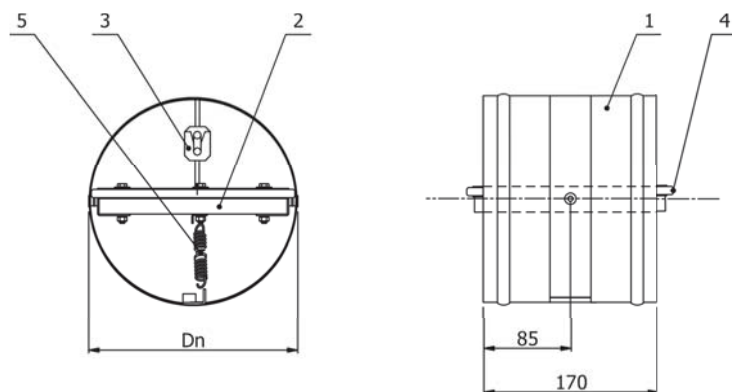

Wooden supports during mounting

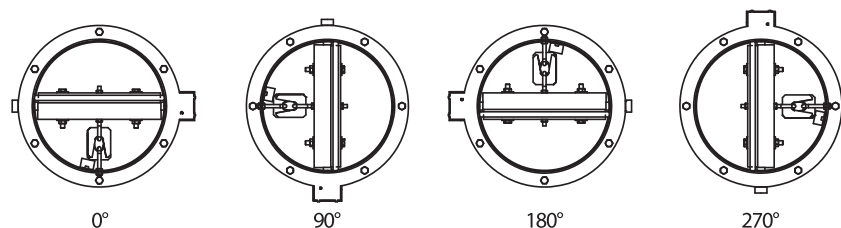

Recommended positions of fire damper

Order code _____

PL-10-1/AFi diameter

The charts below show the ventilation shaft size as a function of number of storeys in the multi-storey buildings with mono-pipe ventilation system.

60 m³/h

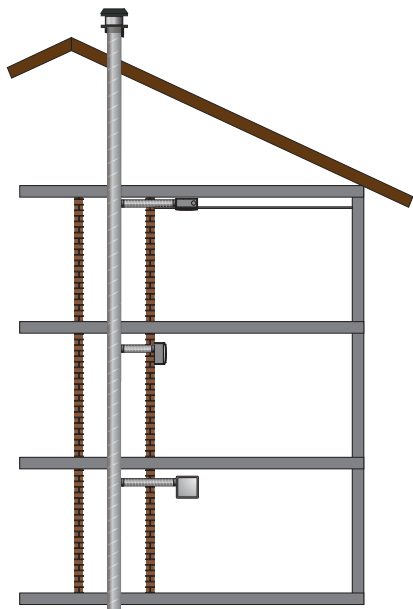

One fan for a shaft

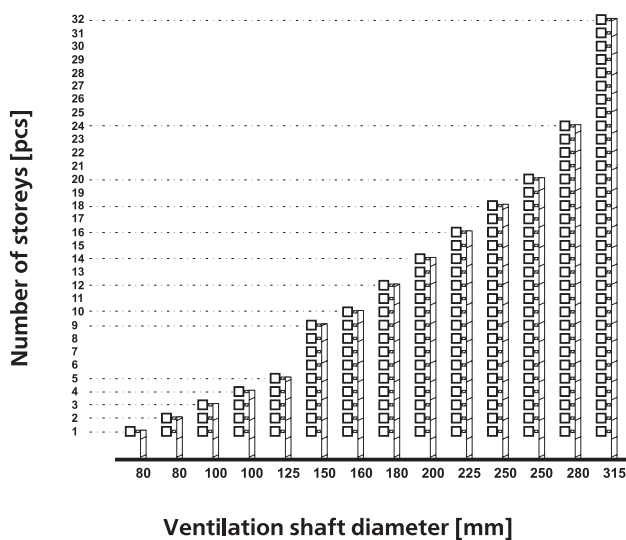

60 m³/h

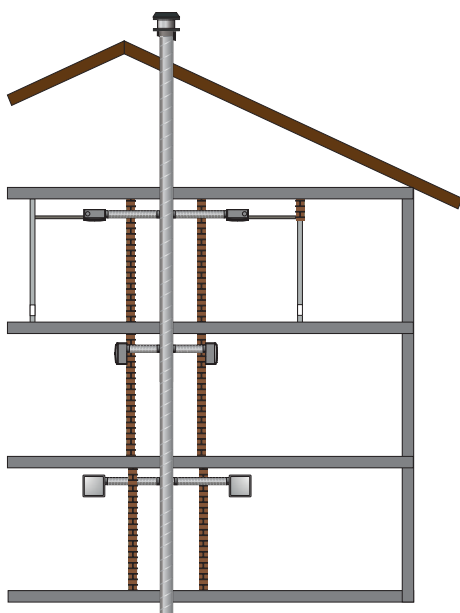

Two fans for a shaft

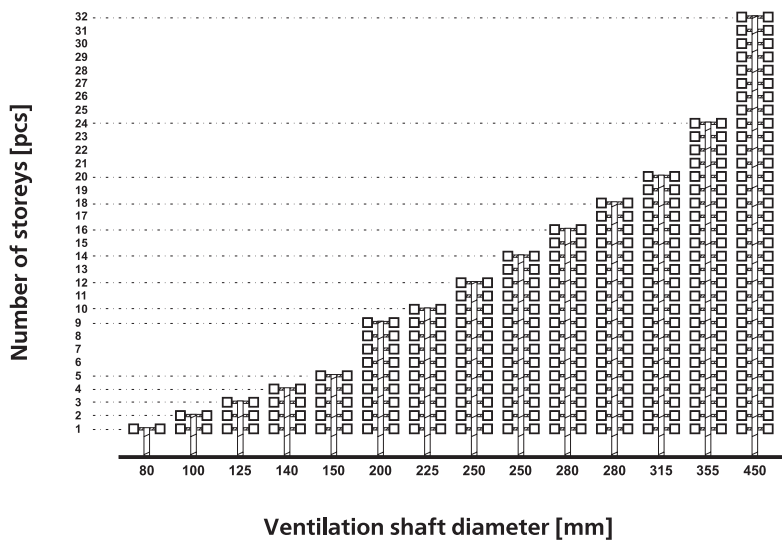

100 m³/h

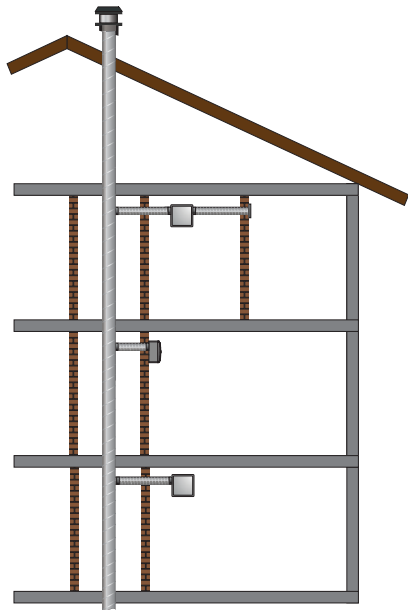

One fan for a shaft

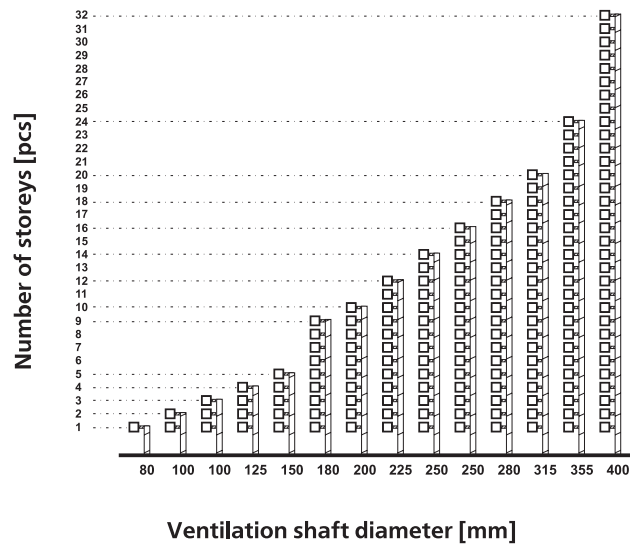

100 m³/h

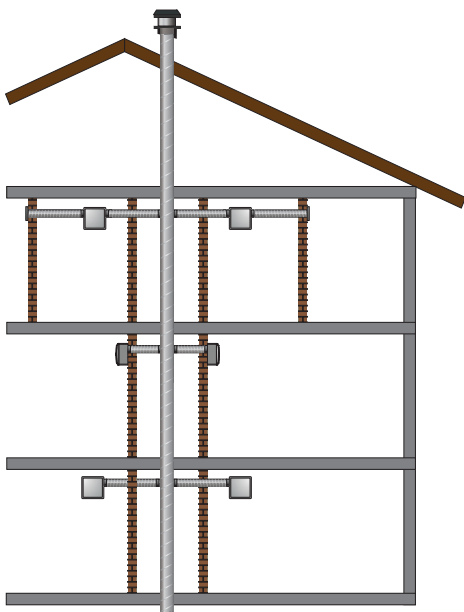

Two fans for a shaft

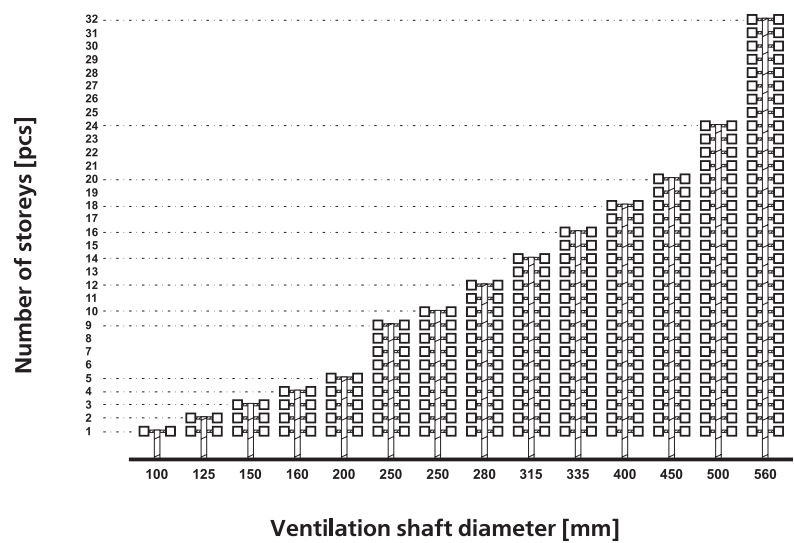

■ Connection of basic three-speed fan models

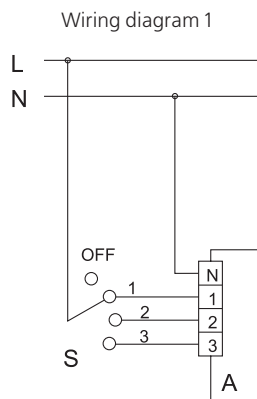

The fan can be switched on to one of three available speeds manually with the external speed switch S (e.g. P3-1-300) or switched off.

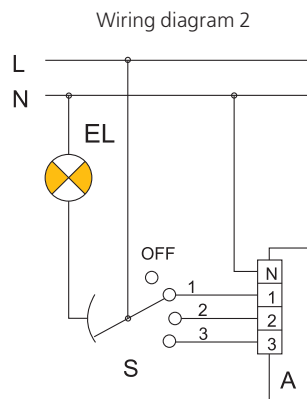

The fan can be switched on to one of three available speeds manually with the external speed switch S (e.g. P3-1-300) with parallel turning on the light in the room or switched off with parallel turning off the light in the room. The fan cannot be switched on without turning on the light and vice versa.

VNV-1 80
VNV-1 80 KP
VNV-1 80 KV
VN-1 80
VN 80
VNV-1 80 KVK
VN-1 80 K
VN 80 K

VNV-1C 80
VNV-1C 80 KP
VNV-1C 80 KV
VN-1C 80
VN-C 80
VNV-1C 80 KVK
VN-1C 80 K
VN-C 80 K

■ Connection of basic two-speed fan models

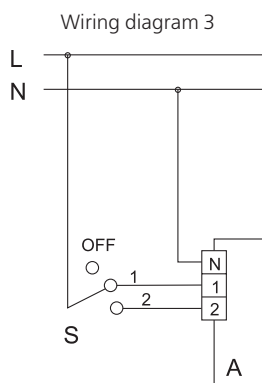

The fan can be switched on to one of two speeds manually with the external speed switch S (e.g. P3-1-300) or switched off.

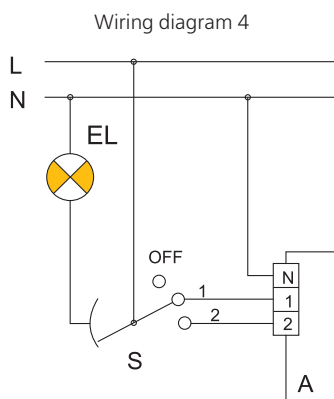

The fan can be switched on to one of two speeds manually with the external speed switch S (e.g. P3-1-300) with parallel turning on the light in the room or switched off with parallel turning off the light in the room. The fan cannot be switched on without turning on the light and vice versa.

VNV-1(A,B,D) 80
VNV-1(A,B,D) 80 KP
VNV-1(A,B,D) 80 KV
VN-1(A,B,D) 80
VN-(A,B,D) 80

VNV-1(A,B,D) 80 KVK
VNV-1(A,B,D) 80 K
VN-1(A,B,D) 80 K

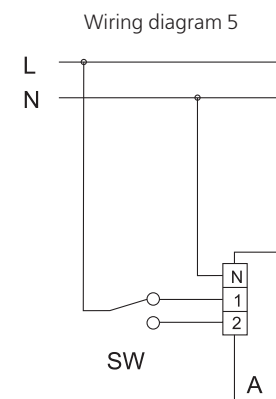

The fan runs permanently at the first speed or second speed. The speed is selected with SW switch.

■ Connection of basic two-speed fan models with timer (T), regulated timer (TR) or interval switch (I)

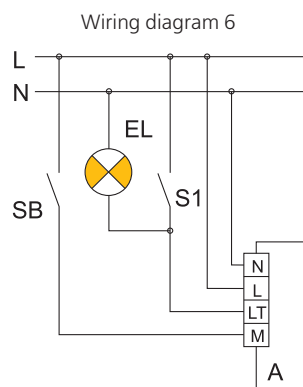

Timer (T) or regulated timer (TR) modification:

The fan with T and TR modification runs permanently at the first speed with the closed SB switch or is switched off as the switch is open. The fan can be switched on to the second speed manually with S1 switch with parallel turning on the light in the room. Turn-on delay time for the second speed then makes 50 seconds for T modification and from 0 to 150 seconds for TR modification. After switching off S1 switch the light in the room is turned off, but the fan keeps running for the time period set by the timer, i.e. 6 minutes for T modification and from 2 up to 30 minutes for TR modification, then it switches automatically to the first speed or switches off.

VNV-1(A,B,D) 80 (T, TR, I)
VNV-1(A,B,D) 80 KP (T, TR, I)
VNV-1(A,B,D) 80 KV (T, TR, I)
VN-1(A,B,D) 80 (T, TR, I)
VN-(A,B,D) 80 (T, TR, I)

VNV-1(A,B,D) 80 KVK (T, TR, I)
VNV-1(A,B,D) 80 K (T, TR, I)
VN-(A,B,D) 80 K (T, TR, I)

Interval switch modification (I):

The fan with the interval switch (I) permanently runs at the first speed with the closed SB switch or is switched off as the switch is open. The fan periodically switches to the second speed within the switching interval from 0.5 to 15 hours set manually and continues operating with the second speed within 10 minutes. The fan can be switched on to the second speed manually with S1 switch with parallel turning on the light in the room. Turn-on delay time for the second speed then makes 50 seconds. After switching off S1 switch the light in the room is turned off and the fan resets to the interval operation mode.

■ Connection of two-speed fan models with built-in photosensor (F)



Wiring diagram 7

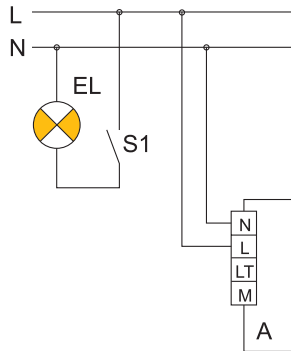

The fan is switched off in the starting position. As the light is turned on in the room, the fan switches to the second speed operation by means of the photosensor. Turn-on delay time for the second speed is 50 seconds. After turning off the light, the fan keeps operating within the time period set by the timer from 2 to 30 minutes, then it switches off automatically. The first speed is not used in this diagram.

Wiring diagram 8

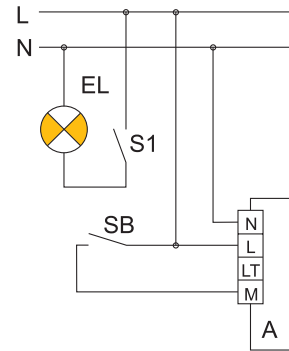

VNV-1(A,B,D) 80 F
VNV-1(A,B,D) 80 KP F
VNV-1(A,B,D) 80 KV F
VN-1(A,B,D) 80 F
VN-(A,B,D) 80 F

VNV-1(A,B,D) 80 KV K F
VN-1(A,B,D) 80 K F
VN-(A,B,D) 80 K F

The fan permanently runs at the first speed with the closed SB switch or is switched off when the switch is open. When the light is turned on in the room, the fan switches to the second speed by means of the photosensor. Turn-on delay time for the second speed is 50 seconds. After turning off the light, the fan keeps running within the time period set by the timer from 2 to 30 minutes, and then switches automatically to the first speed or switches off.

■ Connection of two-speed fan models with humidity sensor (H)



Wiring diagram 9

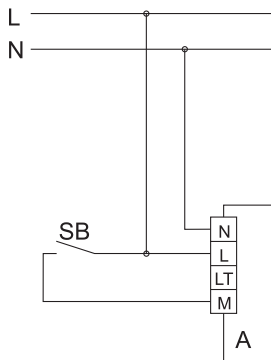

The fan runs at the first speed with the closed switch SB or is switched off when the switch is open. As the relative humidity level in the room increases, the fan switches automatically on to the second speed and run so till the humidity level drops to the required value.

Wiring diagram 10

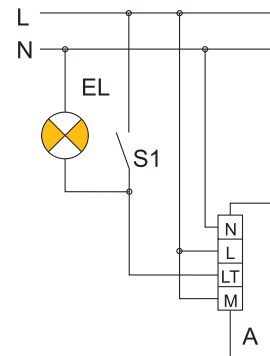

VNV-1(A,B,D) 80 H
VNV-1(A,B,D) 80 KP H
VNV-1(A,B,D) 80 KV H
VN-1(A,B,D) 80 H
VN-(A,B,D) 80 H

VNV-1(A,B,D) 80 KV K H
VN-1(A,B,D) 80 K H
B-(A,B,D) 80 K H

The fan runs constantly at the first speed. As the relative humidity level in the room increases, the fan automatically switches on to the second speed and runs so till the humidity level drops to the required value. Additionally, the fan can be switched on to the second speed or switched off manually with S1 switch parallel with the light in the room. Turn-on delay time for the second speed is 50 seconds.

Wiring diagram 11

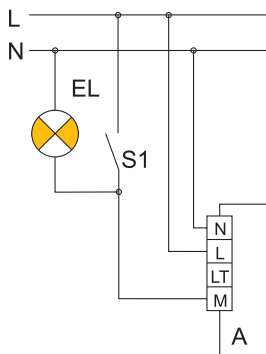

The fan runs at the first speed if the light in the room is turned on with switch S1 or is switched off if the light is turned off. As the relative humidity level in the room increases, the fan switches automatically to the second speed and runs so till humidity level drops to the required value regardless to S1 position.

Wiring diagram 12

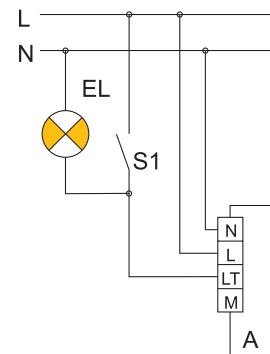

The fan is switched off in the starting position. As the relative humidity level in the room increases, the fan switches automatically to the second speed and runs so till the humidity level drops to the required value. Additionally, the fan can be switched on to the second speed manually with switch S1 or switched off parallel with the light in the room. Turn-on delay time for the second speed makes 50 seconds. The first speed is not used in this diagram.

VENTILATION SYSTEM ARRANGEMENT EXAMPLE

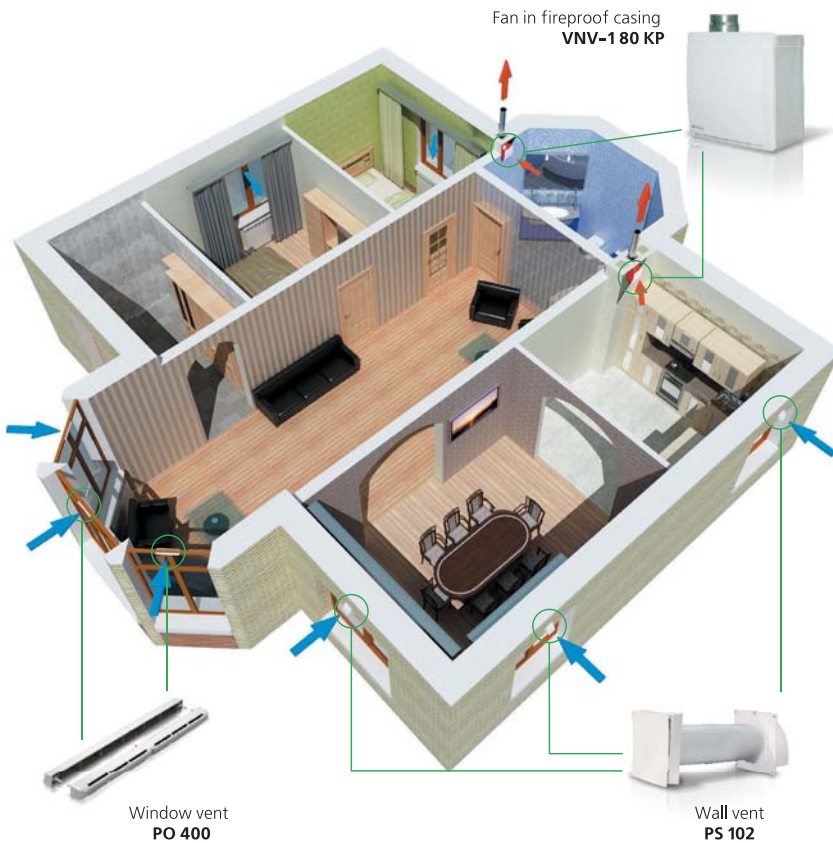

Air exchange arrangement requires special attention in modern residential construction. Lack of ventilation caused by airtight windows cannot be solved with old technical means because of no slots for air intake in such windows. Whatever the cross section of the kitchen or bathroom exhaust vent may be, air flow is not possible without arranged supply ventilation from outside.

Exhaust ventilation of a multi-storey residential building can be arranged as follows. Mechanical exhaust ventilation systems with natural air intake are designed with exhaust fans in a kitchen, bathroom and toilet. The window or wall vents provide air intake from outside. Fresh air is supplied to bedrooms, living rooms and other residential rooms. After air exchange extract air moves through the inner doors to a bathroom, toilet and kitchen, where it is removed by exhaust fans.

1. **VNV** fan for wall flush mounting in fireproof casing
2. **VNV** fan for wall flush mounting in plastic casing
3. **VN** fan for wall surface mounting
4. Roof fan **VKH (VKV)**
5. Wall grille **MV**
6. Wall vent **PS 100, PS 101, PS 102**
7. Door ventilation grille **MV 430/2, MV 450/2**
8. Window vent **PO 400**
9. **Spirovent** air ducts
10. **Aluvent (Thermovent)** air ducts
11. Fire damper **PL 10**

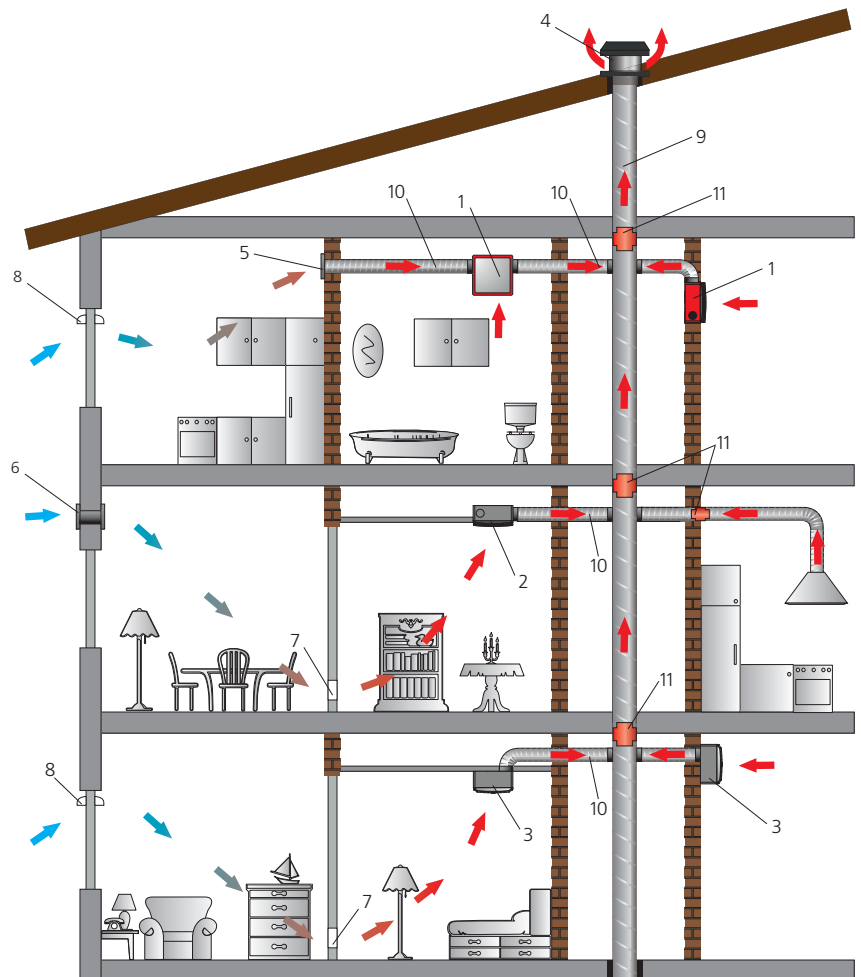

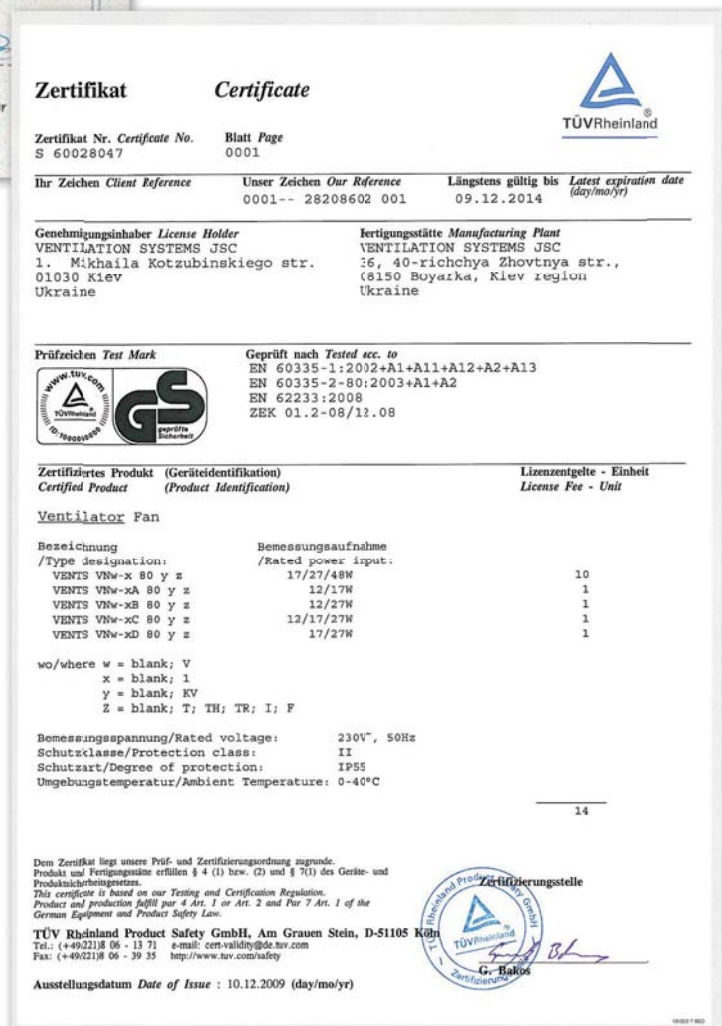

VENTILATION SYSTEM
www.ventilation-system.com

mono-pipe exhaust
ventilation of bathroom
and kitchens

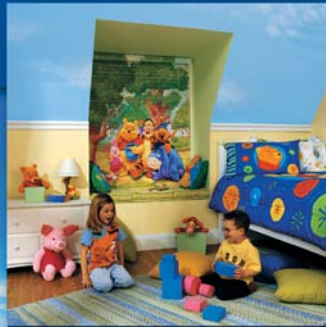

VENTS reserves the rights to modify any of its products' features, designs, components and specifications at any time and without notice to maintain the development and quality of manufactured goods.