

**TRANSFORMER SPEED
CONTROLLERS
RSA5D-...-M SERIES**

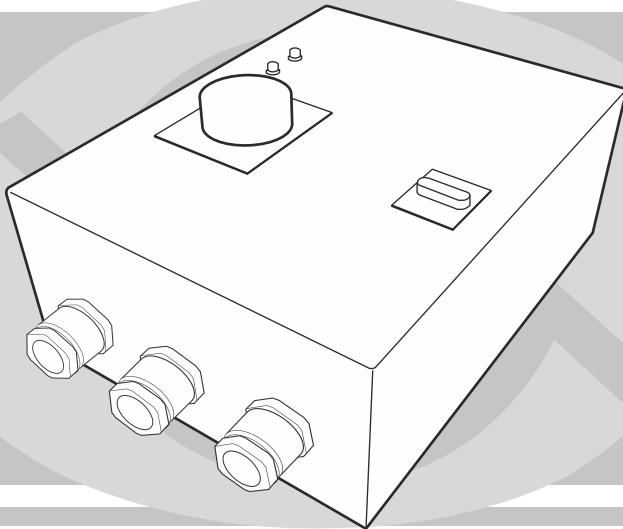

CONTENTS

1	PURPOSE.....	3
2	PACKAGE CONTENTS.....	3
3	TECHNICAL SPECIFICATIONS.....	4
4	DESIGN AND OPERATING PRINCIPLE.....	4
5	SAFETY PRECAUTIONS AND WARNINGS.....	5
6	INSTALLATION AND SETUP.....	6
7	TECHNICAL MAINTENANCE.....	8
8	TRANSPORTATION.....	8
9	WARRANTY.....	8

PURPOSE

The RSA5D-.-M series controllers (hereinafter “Device”) are used to control the output of three-phase fans by step changing of the supplied voltage.

The controller has five speed settings which correspond to five fixed positions of the rotating knob on the front panel.

PACKAGE CONTENTS

- Automatic transformer 1 piece
- User's Operation Manual 1 piece
- Packing 1 piece

Switch Position	Output Voltage, VAC
0	0
1	90
2	150
3	200
4	280
5	400

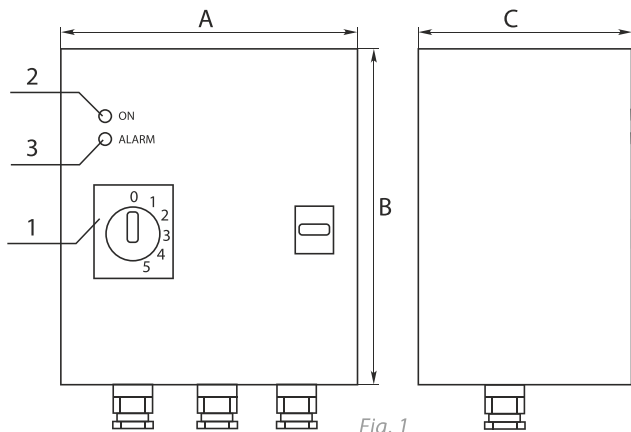

TECHNICAL SPECIFICATIONS

- Supply Voltage: 400V/50 Hz
- Fan Motor Nominal Voltage: 400V/50 Hz
- Lead-In: screw terminal block 0.5 ... 2.5 mm²
- Operating Ambient Temperature: +5°C..+40 °C
- Protection Class: IP44

Designation	RSA5D-5,0-M	RSA5D-8,0-M	RSA5D-10,0-M	RSA5D-12,0-M
Max. Load Current (A)	5,0	8,0	10,0	12,0
Control Circuit Fuse (A)	2,0	0,5	0,5	0,5
Dimensions (mm)	325x250x245	325x250x245	425x300x250	425x300x250
Weight (kg)				

DESIGN AND OPERATING PRINCIPLE

The device is a three-phase transformer enclosed in a metal casing with electric junctions. The device front panel (see Fig. 1) features speed selector 1, signal lamp 2 which indicates normal operation of the controller, and signal lamp 3 which corresponds to controller operation in the emergency mode.

The controller has five speeds selectable by means of rotating knob 1 to one of the five fixed positions or "O" (Off). The controller is equipped with TK terminals (see Fig. 4) for connection of the thermal contact built into the fan motor. When actuated the thermal contact cuts voltage supply to the fan motor and switches on signal lamp 3 which indicates controller operation in the emergency mode. The controller also has terminals L1,N (230VAC/Max. 2A) for connection of external equipment (e.g. air damper actuators). Setting the controller knob to "O" cuts the voltage supply to the fan motor.

SAFETY PRECAUTIONS AND WARNINGS

- ⚠ The controller application range is limited by the fan electric motor characteristics. The fan electric motor must be designed for voltage regulation by means of a transformer.
- ⚠ The speed controller and its connected equipment may present an electric shock hazard. Therefore, the device shall be connected and operated only by adequately qualified staff familiar with this manual. The speed controller belongs to electrical machinery with voltages up to 1,000 V. The device must be disconnected from the power mains for any and all operations with the device internals.
of the electrical appliances connected to the device shall not exceed the limit value (see Technical specifications. The speed controller must be properly earthed.
- ⚠ Use the device with due caution. Do not subject it to shocks and overloads or expose it to liquids and dirt. Should any foreign objects penetrate onto the controller circuit board, disconnect the unit from the mains and remove them.
- ⚠ **Do not apply overvoltage to any of the speed controllers parts while testing the device (e.g. with a megohmmeter etc.). Disconnect the cable from the speed controller prior to any measurements on the cable or motor!**

DO NOT:

- ⊗ Operate the device in the presence of smoke or smell commonly associated with burning insulation, high noise or vibration, in case of structural integrity loss or formation of cracks in the casing or with broken connectors;
- ⊗ Cover the device with any materials, mount any gauges and objects on top, block the vents or fill them with any foreign objects; do not use the device in areas with an explosive or chemically aggressive environment detrimental to metals and insulation or under the influence of droplets or spray; do not use outdoors;
- ⊗ Connect any electric motors (individual or part of any equipment) with the phase current consumption (usually stated on the nameplate) in excess of the limit phase load current for the device;
- ⊗ Connect the device output terminals to the power mains.

INSTALLATION AND SETUP

ATTENTION! Following the device transportation or storage under temperatures below zero let the unit warm up in the specified operating conditions for at least 4 hours.

- Check the device visually for any damage to the casing;
- Open the device front panel (see Fig. 2);
- Fasten the controller to the mounting surface using mounting holes 6 in the rear wall of the unit (see Fig. 2);

ATTENTION!
MOUNT THE DEVICE VERTICALLY
FOR PROPER OPERATION

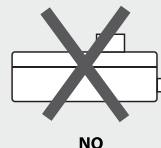
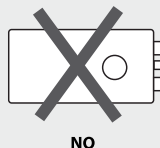

- Complete the electrical connections according to the wiring diagram (see Fig. 4). The external wires are connected to the device by means of bolt-and-nut terminals 5 (see Fig 3). The cables are routed into the unit through sealed lead-ins 4 (see Fig.3). The external lead-in (400V/50Hz) must be equipped with an automatic switch built into the stationary wiring. Supply the power voltage and start the device.

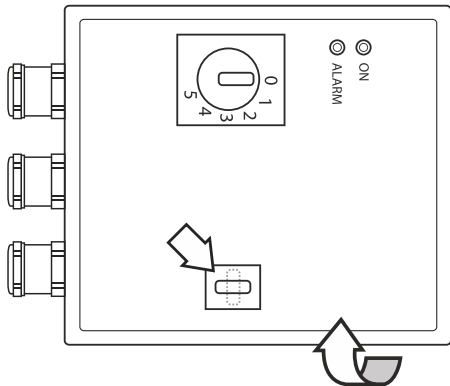

Fig. 2

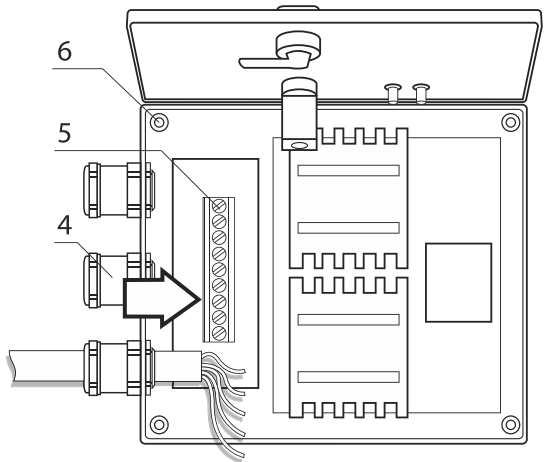

Fig. 3

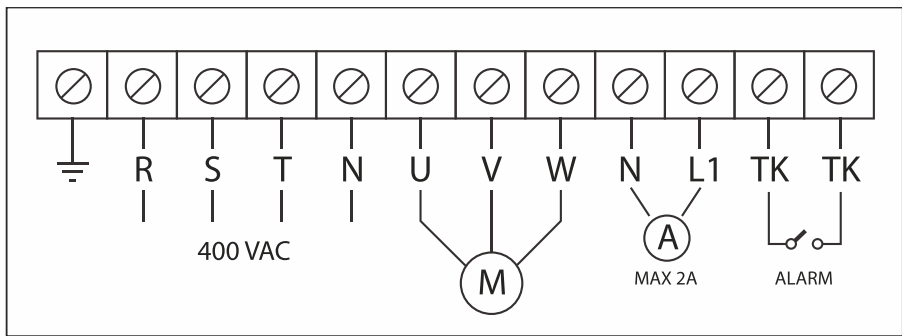

Fig. 4 Connection Diagram

TECHNICAL MAINTENANCE

- Periodically clean dust, fibres and other contamination from the ventilation holes.
- Make sure the external wires are tightly connected to the screw terminals of the device

TRANSPORTATION

The device shall be carried in the manufacturer's packing without limitation to the means of transport, distance or speed. Once received by the user the devices shall be stored in the original packing at temperatures ranging from -40 to +35 °C and relative humidity up to 80%. The storage premises shall be free from dust and corrosive acid or alkaline vapours.

WARRANTY

The manufacturer warrants trouble-free operation of the speed controller over the period of 12 months from the sale date within the warranty storage period. The warranty storage period is 24 months from the manufacturing date. If the sale date and vendor's stamp are missing, the warranty period shall be calculated from the manufacturing date. The customer shall be entitled to free repair of the device in case of any malfunction of the controller occurring through the manufacturer's fault within the warranty period.

ATTENTION! The manufacturer shall not be liable for any injuries or damage caused by non-compliance with the installation and operation regulations set forth herein.

ATTENTION! Check the controller certificate of sale and acceptance for completeness (the required information includes the manufacturing and sale dates, manufacturer's and vendor's stamps).

Warranty service is denied in the following cases:

- Violation of the storage, transportation, installation and operation rules set forth herein;
- Failure to present the original certificate of sale and acceptance providing evidence of sale; Missing warranty card;
- Device repair by unauthorized persons and entities;
- Mechanical damage, traces of chemicals and penetration of foreign objects
- Damage caused by force majeure consequences (e.g. fire, lightning strike, flood, accident etc.);
- Misuse of the device:
- Connection to the power mains non-compliant with the required parameters specified in p.3 of the Operation Manual;
- Connection of loads with current consumption in excess of the maximum permissible current as specified in p.3 of the Operation Manual.

WARRANTY CARD

Acceptance Inspector's Stamp _____

Manufacturing Date _____

Shipment Date _____

FULL NAME _____

Date _____

Signature _____

NOTES

**TRANSFORMER SPEED CONTROLLERS
RSA5D-.-M SERIES**

