

ACCESS DOORS



2020

Fresh air in
your house!

WELCOME TO THE VENTS WORLD!



VENTS company was founded in the nineties of the XXth century.

Dynamic development of the enterprise and ongoing study of the consumer demand enabled rapid international leadership of the company in the ventilation industry.

VENTS is a powerful research and development enterprise with 3000 professionals working as a single team to ensure a full production cycle from idea to end product.

The production base of the company is located at more than 90 000 m² area. It includes 16 workshops equipped under the latest international standards and each of them is comparable to a separate plant.

Modern equipment, active implementation of advanced technologies and highly automated production are the characteristic features of VENTS company.

The company undergoes rapid dynamic development; fundamental researches and effective designs in climatic equipment industry are in the focus of the company's business strategy.

"The joint cooperation of the corporate design department, test laboratories and production workshops let us introduce high quality products to the market."

Special attention is paid to the manufacturing of the goods during all manufacturing stages including monitoring of the technological conditions. Technical characteristics of supplied raw materials are thoroughly checked.

Quality control system which meets international standard requirements ISO 9001:2000 was implemented at the enterprise.

Environmental protection is one of the basic components of the corporate strategy.

The technological process at the enterprise is arranged in such a way as to exclude any negative impact to the environment. To solve the global energy saving problem we develop a special climatic equipment that provides comfortable conditions for people and reduces the energy demand significantly.

Perfect quality, competitive prices, high production potential, technical capabilities and the wide product range stimulate long-term partnership and product promotion all over the world.

The VENTS ventilation products are exported to more than 90 countries and are sold through the distribution network of 120 companies worldwide. The global share of the VENTS products is above 10%.

VENTS is a member of high-rank international organizations, the leading HVAC experts.

Since 2008 VENTS has been a fully-featured member of HARDI Association (Heating, Air-conditioning and Refrigeration Distributors International, USA).

Since 2010 VENTS has been a participant of AMCA Association (The Air Movement and Control Association (AMCA) International, Inc.).

In 2011 VENTS successfully passed tests for compliance with AMCA standards and the VENTS products were certified for the USA market.

In 2011 VENTS joined HVI (Home Ventilation Institute, USA) Association.





Metal processing workshop



Spiral air ducts workshop



Flexible air ducts workshop



Aluminium grilles and diffusers workshop



Powder coating workshop



Wet coating workshop



Extrusion workshop



Injection moulding workshop



Residential fans workshop



Ventilation grilles workshop



Electric motors workshop



Industrial fans workshop



Air handling units workshop



AirVents air handling unit workshop



Electrical accessories workshop



Extruded grilles workshop

Powerful production facilities, high automation level, active implementation of innovative technologies in the production process made VENTS a worldwide ventilation leader.

We manufacture our products with respect to unique geographical, climatic, technical features of each country and do our best to fulfil the client's wishes anywhere anytime.

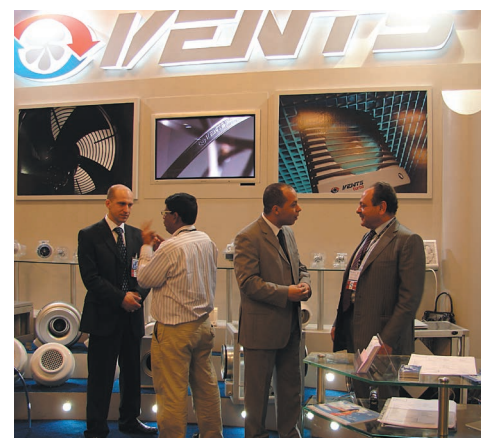

Get benefit from cooperation with VENTS TM and enjoy the maximum range of products of the top quality from one manufacturer.

ACCESS DOORS FOR ACCESSING CONCEALED EQUIPMENT AND UTILITY LINES



**Access doors
D (D2) series**
Plastic

page
5



**Access doors
DPV series**
Plastic

page
6



**Access doors
DZ series**
Plastic
(with lock)

page
7



**Access doors
DD series**
Plastic
(double sided hinges)

page
8



**Access doors
DM series**
Metal

page
9



**Access doors
DMZ series**
Metal
(with lock)

page
10

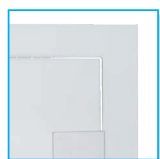

**Access doors
DMR series**
Metal

page
11



**Access doors
DMV series**
Metal

page
12



**Access doors
DKP series**
Recessed for
ceramic tiles

page
13



**Access doors
DKM series**
Recessed for
ceramic tiles

page
14



**Access doors
DG series**
Designed for plasterboard
wall or ceiling application

page
15

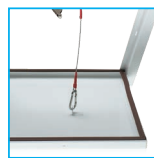

**Access doors
DPM series**
Designed for
ceiling mounting

page
16

D series



D2 series



Plastic access doors opening from either side

Application

- Designed for wall or ceiling application.
- Enable quick and convenient access to concealed equipment and utility lines.
- Suitable for high-humidity areas.
- Protected by national patents worldwide.

Design

- Made of high-quality ABS plastic.
- Left or right-side opening.

Sample installations

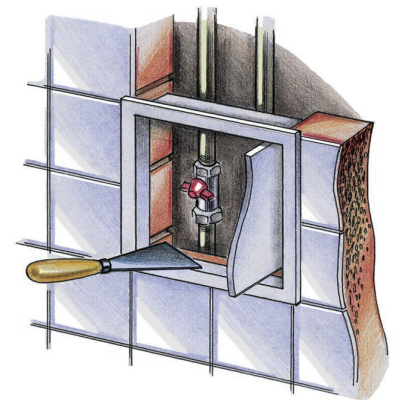
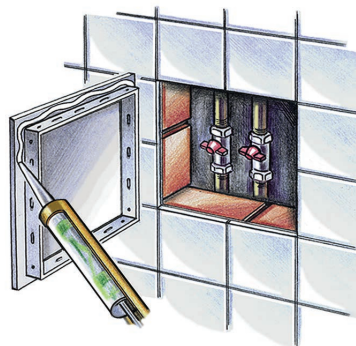

- Press gently to open and close.
- The swinging D2 doors provide maximum clearance while accessing utility lines.
- A wide range of sizes.

Mounting

- Easy mounting using mortar or glue.
- Universal mountings for left or right-side opening.
- Easy servicing.

Dimensions

Model	Dimensions [mm]							
	H	B	H1	B1	H2	L1	L	B2
D 100x100	137	137	93	93	98	5	25	98
D 150x150	167	167	123	123	147	5	25	147
D 150x200	217	167	173	123	197	5	25	147
D 150x300	317	167	273	123	297	5	25	147
D 200x200	217	217	173	173	197	5	25	197
D 200x250	267	217	223	173	247	5	25	197
D 200x300	317	217	273	173	297	5	25	197
D 200x400	417	217	373	173	397	5	25	197
D 250x250	267	267	246	246	247	5	25	247
D 250x300	317	267	273	223	327	5	25	247
D 250x400	417	267	373	223	397	5	25	247
D 300x300	317	317	273	273	297	5	25	297
D 300x400	417	317	373	273	397	5	25	297
D 300x500	517	317	473	273	497	5	25	297
D 300x600	617	317	573	273	597	5	25	297
D 400x500	517	417	473	373	497	5	25	397
D 400x600	617	417	573	373	597	5	25	397
D2 300x300	317	288	273	244	297	5	25	268
D2 400x400	416	388	372	344	397	5	25	370

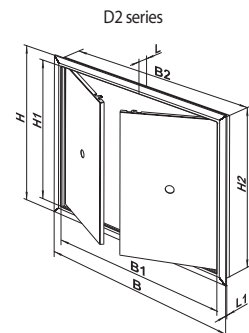
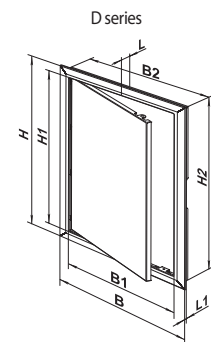

Color options



White



Beige



Grey



Sky Blue



Beige Marble



Grey Marble



Blue Marble



Green Marble

DPV series



Plastic access doors opening from either side

Application

- Designed for wall or ceiling application.
- Enable quick and convenient access to concealed equipment and utility lines.
- Suitable for high-humidity areas.
- Protected by national patents worldwide.

Design

- Made of high-quality ABS plastic.

- Left or right-side opening.
- Press gently to open and close.
- A protecting insect screen may be installed as an option (**DPV 200x300 s**).

Mounting

- Easy mounting using mortar or glue.
- Universal mountings for left or right-side opening.
- Easy servicing.

Dimensions

Model	Dimensions [mm]							
	H	B	H1	B1	H2	L1	L	B2
DPV 200x300	317	217	273	173	296	6.5	19.5	196

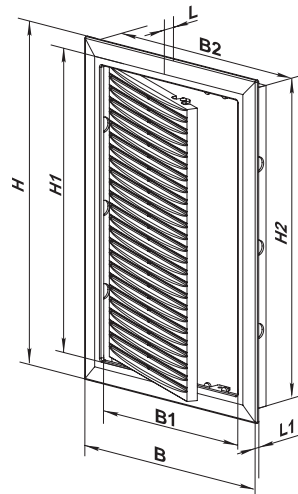

Color options



White



Beige



Grey



Sky Blue



Beige Marble



Grey Marble



Blue Marble



Green Marble

DZ series



Plastic access doors with key lock

Application

- Designed for wall or ceiling application.
- Enable quick and convenient access to concealed equipment and utility lines.
- Suitable for high-humidity areas.
- Protected by national patents worldwide.

Design

- Made of high-quality ABS plastic.
- Left or right-side opening.
- Equipped with a key lock.

Mounting

- Easy mounting using mortar or glue.
- Universal mountings for left or right-side opening.
- Easy servicing.

Sample installations

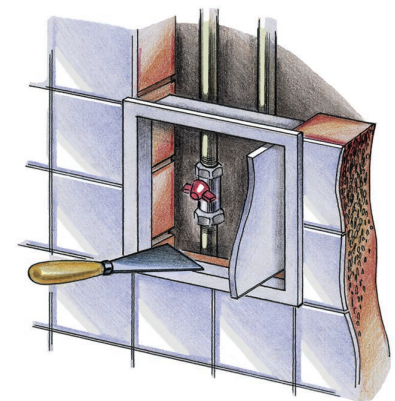
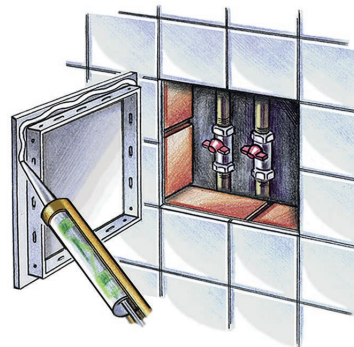

Dimensions

Model	Dimensions [mm]							
	H	B	H1	B1	H2	L1	L	B2
DZ 150x300	317	167	273	123	297	5	25	147
DZ 250x400	417	267	373	223	397	5	25	247
DZ 300x500	517	317	473	273	497	5	25	297
DZ 300x600	617	317	573	273	597	5	25	297
DZ 400x500	517	417	473	373	497	5	25	397
DZ 400x600	617	417	573	373	597	5	25	397

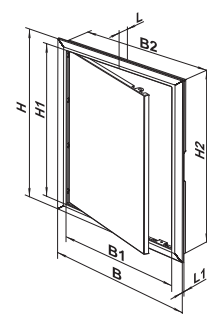

Color options



White



Beige



Grey



Sky Blue



Beige Marble



Grey Marble



Blue Marble



Green Marble

DD series



Plastic access doors with double-sided hinges and paint-ready surface

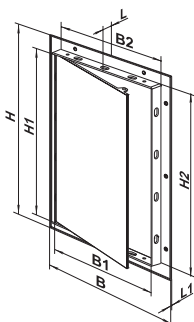
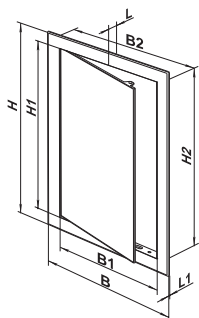

Application

- Designed for wall or ceiling application.
- Enable quick and convenient access to concealed equipment and utility lines.
- Concealed mounting for esthetic appearance.
- Suitable for high-humidity areas.
- Protected by national patents worldwide.

Design

- Made of high-quality ABS plastic.
- The door surface is ready for acrylic and water-dispersion paint or wallpaper application.

- Left or right-side opening.
- Press gently to open and close.
- A wide range of sizes.

Mounting

- Easy mounting using mortar or glue.
- Universal mountings for left or right-side opening.
- Double-sided hinges.
- Easy servicing.

Sample installations

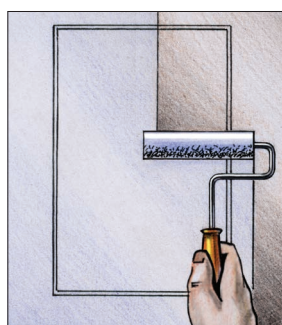

Dimensions

Model	Dimensions [mm]							
	H	B	H1	B1	H2	L1	L	B2
DD 200x300	336	236	291	189	297	3	20	197

Color options



White



Beige



Grey



Sky Blue



Beige Marble



Grey Marble



Blue Marble



Green Marble

DM series



Metal access doors



Magnetic latch

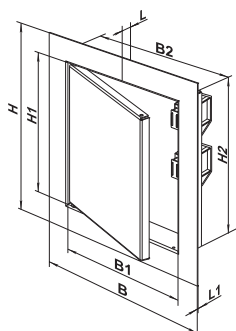

Application

- Designed for wall application.
- Enable quick and convenient access to concealed equipment and utility lines.
- Suitable for high-humidity areas.
- Protected by national patents worldwide.

Design

- Made of high-quality steel with a durable powder coating.
- The use of zinc phosphate compound ensures 100 % coating integrity and provides a reliable corrosion protection.

- Left or right-side opening.
- Equipped with a magnetic latch for convenient opening and closing by gentle pressure.
- A wide range of sizes.
- Custom sizes are available upon request.

Mounting

- Easy mounting using mortar or glue.
- Universal mountings for left or right-side opening.
- Easy servicing.

Dimensions

Model	Dimensions [mm]						
	H	B	H1	B2	H2	B1	L
DM 100x100	136.5	136.5	96.5	98.1	98.1	96.5	25
DM 150x150	186.5	186.5	146.5	148.1	148.1	146.5	25
DM 150x200	236.5	186.5	196.5	148.1	198.1	146.5	25
DM 150x250	286.5	186.5	246.5	148.1	248.1	146.5	25
DM 150x300	336.5	186.5	296.5	148.1	298.1	146.5	25
DM 200x200	236.5	236.5	196.5	198.1	198.1	196.5	25
DM 200x250	286.5	236.5	246.5	198.1	248.1	196.5	25
DM 200x300	336.5	236.5	296.5	198.1	298.1	196.5	25
DM 200x350	386.5	236.5	346.5	198.1	348.1	196.5	25
DM 200x400	436.5	236.5	396.5	198.1	398.1	196.5	25
DM 200x500	536.5	236.5	496.5	198.1	498.1	196.5	25
DM 225x300	336.5	261.5	296.5	223.1	298.1	221.5	25
DM 225x590	626.5	261.5	586.5	223.1	588.1	221.5	25
DM 250x250	286.5	286.5	246.5	248.1	248.1	246.5	25
DM 250x300	336.5	286.5	296.5	248.1	298.1	246.5	25
DM 250x350	386.5	286.5	346.5	248.1	348.1	246.5	25
DM 250x400	436.5	286.5	396.5	248.1	398.1	246.5	25
DM 250x450	486.5	286.5	446.5	248.1	448.1	246.5	25
DM 300x200	236.5	336.5	196.5	298.1	198.1	296.5	25
DM 300x300	336.5	336.5	296.5	298.1	298.1	296.5	25
DM 300x400	436.5	336.5	396.5	298.1	398.1	296.5	25
DM 300x500	536.5	336.5	496.5	298.1	498.1	296.5	25
DM 300x600	636.5	336.5	596.5	298.1	598.1	296.5	25
DM 350x350	386.5	386.5	346.5	348.1	348.1	346.5	25
DM 400x400	436.5	436.5	396.5	398.1	398.1	396.5	25
DM 400x500	536.5	436.5	496.5	398.1	498.1	396.5	25
DM 400x600	636.5	436.5	596.5	398.1	598.1	396.5	25
DM 450x250	286.5	486.5	246.5	448.1	248.1	446.5	25
DM 450x450	486.5	486.5	446.5	448.1	448.1	446.5	25
DM 500x500	536.5	536.5	496.5	498.1	498.1	496.5	25
DM 500x600	636.5	536.5	596.5	498.1	598.1	496.5	25
DM 500x800	836.5	536.5	796.5	498.1	798.1	496.5	25
DM 555x555	591.5	591.5	551.5	553.1	553.1	551.5	25
DM 600x400	436.5	636.5	396.5	598.1	398.1	596.5	25
DM 600x600	636.5	636.5	596.5	598.1	598.1	596.5	25
DM 600x800	836.5	636.5	796.5	598.1	798.1	596.5	25

Color options



White



Beige



Brown



Grey



Sky Blue



Black

DMZ series



Metal access doors



Key lock

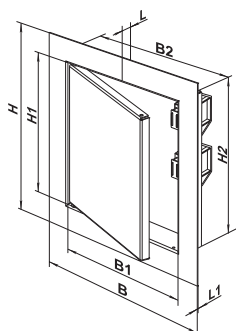

Application

- Designed for wall or ceiling application.
- Enable quick and convenient access to concealed equipment and utility lines.
- Suitable for high-humidity areas.
- Protected by national patents worldwide.

Design

- Made of high-quality steel with a durable powder coating.
- The use of zinc phosphate compound ensures 100 % coating integrity and provides a reliable corrosion protection.

- Left or right-side opening.
- Equipped with a key lock.
- A wide range of sizes.
- Custom sizes are available upon request.

Mounting

- Easy mounting using mortar or glue.
- Universal mountings for left or right-side opening.
- Easy servicing.

Dimensions

Model	Dimensions [mm]						
	H	B	H1	B2	H2	B1	L
DMZ 100x100	136.5	136.5	96.5	98.1	98.1	96.5	25
DMZ 150x150	186.5	186.5	146.5	148.1	148.1	146.5	25
DMZ 150x200	236.5	186.5	196.5	148.1	198.1	146.5	25
DMZ 150x250	286.5	186.5	246.5	148.1	248.1	146.5	25
DMZ 150x300	336.5	186.5	296.5	148.1	298.1	146.5	25
DMZ 200x200	236.5	236.5	196.5	198.1	198.1	196.5	25
DMZ 200x250	286.5	236.5	246.5	198.1	248.1	196.5	25
DMZ 200x300	336.5	236.5	296.5	198.1	298.1	196.5	25
DMZ 200x350	386.5	236.5	346.5	198.1	348.1	196.5	25
DMZ 200x400	436.5	236.5	396.5	198.1	398.1	196.5	25
DMZ 200x500	536.5	236.5	496.5	198.1	498.1	196.5	25
DMZ 225x300	336.5	261.5	296.5	223.1	298.1	221.5	25
DMZ 225x590	626.5	261.5	586.5	223.1	588.1	221.5	25
DMZ 250x250	286.5	286.5	246.5	248.1	248.1	246.5	25
DMZ 250x300	336.5	286.5	296.5	248.1	298.1	246.5	25
DMZ 250x350	386.5	286.5	346.5	248.1	348.1	246.5	25
DMZ 250x400	436.5	286.5	396.5	248.1	398.1	246.5	25
DMZ 250x450	486.5	286.5	446.5	248.1	448.1	246.5	25
DMZ 300x200	236.5	336.5	196.5	298.1	198.1	296.5	25
DMZ 300x300	336.5	336.5	296.5	298.1	298.1	296.5	25
DMZ 300x400	436.5	336.5	396.5	298.1	398.1	296.5	25
DMZ 300x500	536.5	336.5	496.5	298.1	498.1	296.5	25
DMZ 300x600	636.5	336.5	596.5	298.1	598.1	296.5	25
DMZ 350x350	386.5	386.5	346.5	348.1	348.1	346.5	25
DMZ 400x400	436.5	436.5	396.5	398.1	398.1	396.5	25
DMZ 400x500	536.5	436.5	496.5	398.1	498.1	396.5	25
DMZ 400x600	636.5	436.5	596.5	398.1	598.1	396.5	25
DMZ 450x250	286.5	486.5	246.5	448.1	248.1	446.5	25
DMZ 450x450	486.5	486.5	446.5	448.1	448.1	446.5	25
DMZ 500x500	536.5	536.5	496.5	498.1	498.1	496.5	25
DMZ 500x600	636.5	536.5	596.5	498.1	598.1	496.5	25
DMZ 500x800	836.5	536.5	796.5	498.1	798.1	496.5	25
DMZ 555x555	591.5	591.5	551.5	553.1	553.1	551.5	25
DMZ 600x400	436.5	636.5	396.5	598.1	398.1	596.5	25
DMZ 600x600	636.5	636.5	596.5	598.1	598.1	596.5	25
DMZ 600x800	836.5	636.5	796.5	598.1	798.1	596.5	25

Color options



White



Beige



Brown



Grey



Sky Blue



Black

DMR series



Metal access doors with a plastic handle



Plastic handle provides additional convenience while opening and closing

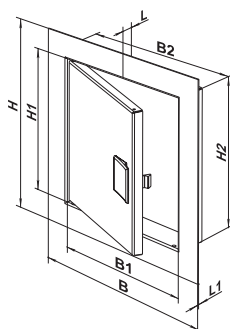

Application

- Designed for wall application.
- Enable quick and convenient access to concealed equipment and utility lines.
- Suitable for high-humidity areas.
- Protected by national patents worldwide.

Design

- Made of high-quality steel with a durable powder coating.
- The use of zinc phosphate compound ensures 100 % coating integrity and provides a reliable corrosion protection.

- Left or right-side opening.
- Equipped with a plastic handle for easy opening and closing.
- A wide range of sizes.
- Custom sizes are available upon request.

Mounting

- Easy mounting using mortar or glue.
- Universal mountings for left or right-side opening.
- Easy servicing.

Dimensions

Model	Dimensions [mm]						
	H	B	H1	B2	H2	B1	L
DMR 100x100	136.5	136.5	96.5	98.1	98.1	96.5	25
DMR 150x150	186.5	186.5	146.5	148.1	148.1	146.5	25
DMR 150x200	236.5	186.5	196.5	148.1	198.1	146.5	25
DMR 150x250	286.5	186.5	246.5	148.1	248.1	146.5	25
DMR 150x300	336.5	186.5	296.5	148.1	298.1	146.5	25
DMR 200x200	236.5	236.5	196.5	198.1	198.1	196.5	25
DMR 200x250	286.5	236.5	246.5	198.1	248.1	196.5	25
DMR 200x300	336.5	236.5	296.5	198.1	298.1	196.5	25
DMR 200x350	386.5	236.5	346.5	198.1	348.1	196.5	25
DMR 200x400	436.5	236.5	396.5	198.1	398.1	196.5	25
DMR 225x300	336.5	261.5	296.5	223.1	298.1	221.5	25
DMR 225x590	626.5	261.5	586.5	223.1	588.1	221.5	25
DMR 250x250	286.5	286.5	246.5	248.1	248.1	246.5	25
DMR 250x300	336.5	286.5	296.5	248.1	298.1	246.5	25
DMR 250x350	386.5	286.5	346.5	248.1	348.1	246.5	25
DMR 250x400	436.5	286.5	396.5	248.1	398.1	246.5	25
DMR 250x450	486.5	286.5	446.5	248.1	448.1	246.5	25
DMR 300x200	236.5	336.5	196.5	298.1	198.1	296.5	25
DMR 300x300	336.5	336.5	296.5	298.1	298.1	296.5	25
DMR 300x400	436.5	336.5	396.5	298.1	398.1	296.5	25
DMR 300x500	536.5	336.5	496.5	298.1	498.1	296.5	25
DMR 300x600	636.5	336.5	596.5	298.1	598.1	296.5	25
DMR 350x350	386.5	386.5	346.5	348.1	348.1	346.5	25
DMR 400x400	436.5	436.5	396.5	398.1	398.1	396.5	25
DMR 400x500	536.5	436.5	496.5	398.1	498.1	396.5	25
DMR 400x600	636.5	436.5	596.5	398.1	598.1	396.5	25
DMR 450x250	286.5	486.5	246.5	448.1	248.1	446.5	25
DMR 450x450	486.5	486.5	446.5	448.1	448.1	446.5	25
DMR 500x500	536.5	536.5	496.5	498.1	498.1	496.5	25
DMR 500x600	636.5	536.5	596.5	498.1	598.1	496.5	25
DMR 500x800	836.5	536.5	796.5	498.1	798.1	496.5	25
DMR 555x555	591.5	591.5	551.5	553.1	553.1	551.5	25
DMR 600x400	436.5	636.5	396.5	598.1	398.1	596.5	25
DMR 600x600	636.5	636.5	596.5	598.1	598.1	596.5	25
DMR 600x800	836.5	636.5	796.5	598.1	798.1	596.5	25

Color options



White



Beige



Brown



Grey



Sky Blue



Black

DMV series



Metal access doors with ventilation openings

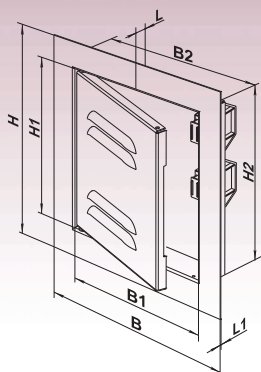

Application

- Designed for wall application.
- Enable quick and convenient access to concealed equipment and utility lines.
- Suitable for high-humidity areas.
- Protected by national patents worldwide.

Design

- Made of high-quality steel with a durable powder coating.
- The use of zinc phosphate compound ensures 100 % coating integrity and provides a reliable corrosion protection.

- Ventilation openings supply additional air into the space behind the door.
- Left or right-side opening.
- Equipped with a plastic handle for easy opening and closing.
- A wide range of sizes.
- Custom sizes are available upon request.

Mounting

- Easy mounting using mortar or glue.
- Universal mountings for left or right-side opening.
- Easy servicing.

Dimensions

Model	Dimensions [mm]						
	H	B	H1	B2	H2	B1	L
DMV 100x100	136.5	136.5	96.5	98.1	98.1	96.5	25
DMV 150x150	186.5	186.5	146.5	148.1	148.1	146.5	25
DMV 150x200	236.5	186.5	196.5	148.1	198.1	146.5	25
DMV 150x250	286.5	186.5	246.5	148.1	248.1	146.5	25
DMV 150x300	336.5	186.5	296.5	148.1	298.1	146.5	25
DMV 200x200	236.5	236.5	196.5	198.1	198.1	196.5	25
DMV 200x250	286.5	236.5	246.5	198.1	248.1	196.5	25
DMV 200x300	336.5	236.5	296.5	198.1	298.1	196.5	25
DMV 200x350	386.5	236.5	346.5	198.1	348.1	196.5	25
DMV 200x400	436.5	236.5	396.5	198.1	398.1	196.5	25
DMV 225x300	336.5	261.5	296.5	223.1	298.1	221.5	25
DMV 225x590	626.5	261.5	586.5	223.1	588.1	221.5	25
DMV 250x250	286.5	286.5	246.5	248.1	248.1	246.5	25
DMV 250x300	336.5	286.5	296.5	248.1	298.1	246.5	25
DMV 250x350	386.5	286.5	346.5	248.1	348.1	246.5	25
DMV 250x400	436.5	286.5	396.5	248.1	398.1	246.5	25
DMV 250x450	486.5	286.5	446.5	248.1	448.1	246.5	25
DMV 300x200	236.5	336.5	296.5	298.1	198.1	196.5	25
DMV 300x300	336.5	336.5	296.5	298.1	298.1	296.5	25
DMV 300x400	436.5	336.5	396.5	298.1	398.1	296.5	25
DMV 300x500	536.5	336.5	496.5	298.1	498.1	296.5	25
DMV 300x600	636.5	336.5	596.5	298.1	598.1	296.5	25
DMV 350x350	386.5	386.5	346.5	348.1	348.1	346.5	25
DMV 400x400	436.5	436.5	396.5	398.1	398.1	396.5	25
DMV 400x500	536.5	436.5	496.5	398.1	498.1	396.5	25
DMV 400x600	636.5	436.5	596.5	398.1	598.1	396.5	25
DMV 450x250	286.5	486.5	446.5	448.1	248.1	246.5	25
DMV 450x450	486.5	486.5	446.5	448.1	448.1	446.5	25
DMV 500x500	536.5	536.5	496.5	498.1	498.1	496.5	25
DMV 500x600	636.5	536.5	596.5	498.1	598.1	496.5	25
DMV 500x800	836.5	536.5	796.5	498.1	798.1	496.5	25
DMV 555x555	591.5	591.5	551.5	553.1	553.1	551.5	25
DMV 600x400	436.5	636.5	596.5	598.1	398.1	396.5	25
DMV 600x600	636.5	636.5	596.5	598.1	598.1	596.5	25
DMV 600x800	836.5	636.5	596.5	598.1	798.1	796.5	25

Color options



White



Beige



Brown



Grey



Sky Blue



Black

DKP series

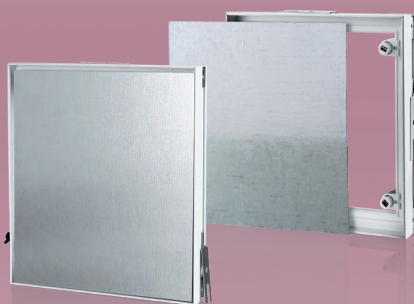

Access doors on a PVC frame for attaching ceramic tiles

Sample installations

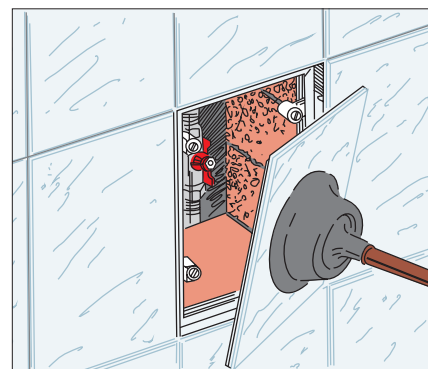
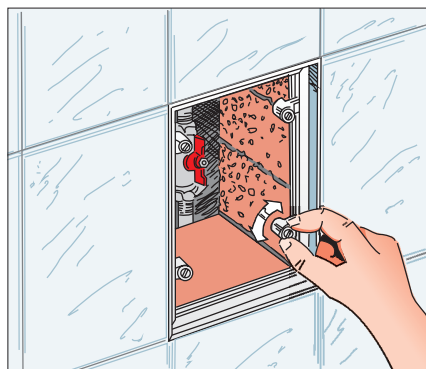
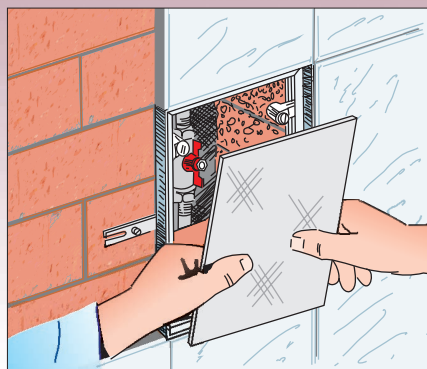

Application

- Designed for wall installation and ceramic tile attachment.
- Enable quick and convenient access to concealed equipment and utility lines.
- Concealed mounting for esthetic appearance.
- Suitable for high-humidity areas.
- Protected by national patents worldwide.

Design

- The PVC profile frame contains magnets and hides the tile-to-tile gap.

- Metal plate for attaching ceramic tiles.
- Magnetic attachment of plate to the frame.
- Press gently to open and close or use a cup plunger.
- A wide range of sizes.

Mounting

- Easy installation using spacers lugs.
- Height-adjustable magnets enable perfect leveling of tiles to the wall surface.
- Ceramic tiles are easily glued to the plate.
- Easy servicing.

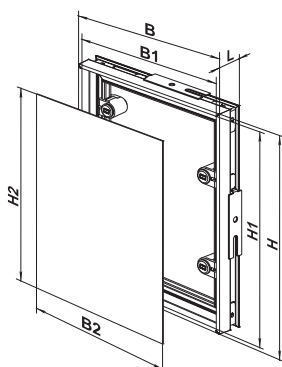

Dimensions

Model	Dimensions [mm]						
	B	H	B2	H2	B1	H1	L
DKP 150x150	156	156	145	145	153	153	30
DKP 150x200	156	206	145	195	153	203	30
DKP 150x300	156	306	145	295	153	303	30
DKP 200x200	206	206	195	195	203	203	30
DKP 200x250	206	256	195	245	203	253	30
DKP 200x300	206	306	195	295	203	303	30
DKP 200x350	206	356	195	345	203	353	30
DKP 200x400	206	406	195	395	203	403	30
DKP 200x450	206	456	195	445	203	453	30
DKP 200x500	206	506	195	495	203	503	30
DKP 250x250	256	256	245	245	253	253	30
DKP 250x300	256	306	245	295	253	303	30
DKP 250x350	256	356	245	345	253	353	30
DKP 250x400	256	406	245	395	253	403	30
DKP 300x300	306	306	295	295	303	303	30
DKP 300x350	306	356	295	345	303	353	30
DKP 300x400	306	406	295	395	303	403	30
DKP 300x450	306	456	295	445	303	453	30
DKP 300x500	306	506	295	495	303	503	30
DKP 400x400	406	406	395	395	403	403	30

DKM series

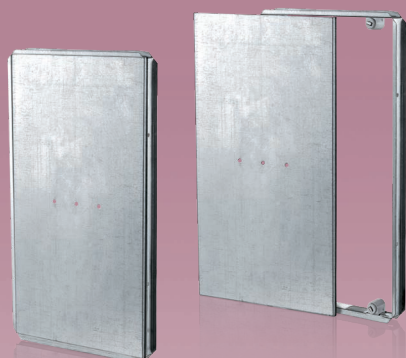

Access doors on a metal frame recessed for ceramic tiles

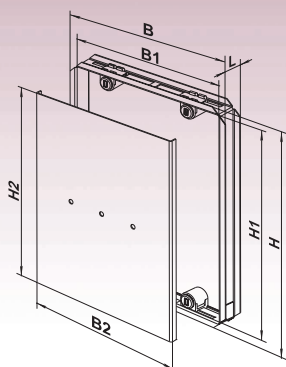

Application

- Designed for wall installation and ceramic tile attachment.
- Enable quick and convenient access to concealed equipment and utility lines.
- Concealed mounting for esthetic appearance.
- Suitable for high-humidity areas.
- Protected by national patents worldwide.

Design

- The metal frame contains magnets for plate attachment and hides the tile-to-tile gap.

- Metal plate for attaching ceramic tiles.
- Magnetic attachment of plate to the frame.
- Press gently to open and close or use a cup plunger.
- A wide range of sizes.

Mounting

- Easy installation using mounting foam or mortar.
- Height-adjustable magnets enable perfect leveling of tiles to the wall surface.
- Ceramic tiles are easily glued to the plate.
- Easy servicing.

Sample Installations

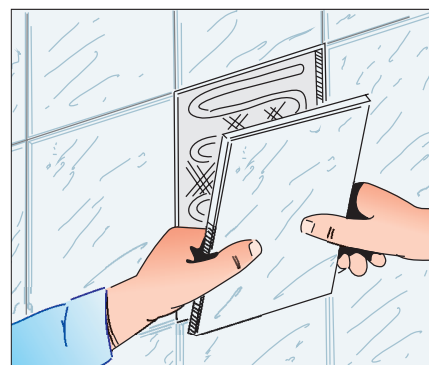
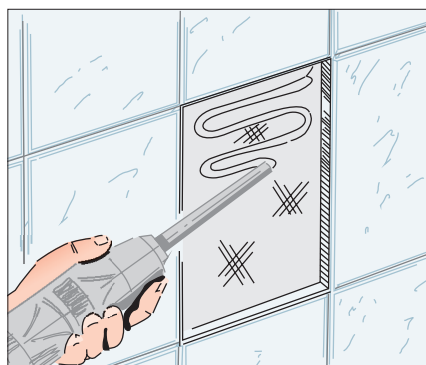

Dimensions

Model	Dimensions [mm]				
	B	H	B2	H2	L
DKM 150x150	163.6	163.6	150	150	26
DKM 150x200	163.6	213.6	150	200	26
DKM 150x250	163.6	263.6	150	250	26
DKM 150x300	163.6	313.6	150	300	26
DKM 200x200	213.6	213.6	200	200	26
DKM 200x250	213.6	263.6	200	250	26
DKM 200x300	213.6	313.6	200	300	26
DKM 200x350	213.6	363.6	200	350	26
DKM 200x400	213.6	413.6	200	400	26
DKM 200x450	213.6	463.6	200	450	26
DKM 200x500	213.6	513.6	200	500	26
DKM 250x250	263.6	263.6	250	250	26
DKM 250x300	263.6	313.6	250	300	26
DKM 250x350	263.6	363.6	250	350	26
DKM 250x400	263.6	413.6	250	400	26
DKM 300x300	313.6	313.6	300	300	26
DKM 300x350	313.6	363.6	300	350	26
DKM 300x400	313.6	413.6	300	400	26
DKM 300x450	313.6	463.6	300	450	26
DKM 300x500	313.6	513.6	300	500	26
DKM 400x400	413.6	413.6	400	400	26
DKM 400x500	413.6	513.6	400	500	26
DKM 500x500	513.6	513.6	500	500	26
DKM 600x600	613.6	613.6	600	600	26

DG series

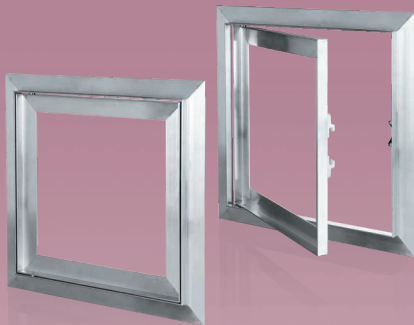

Access doors for plasterboard application

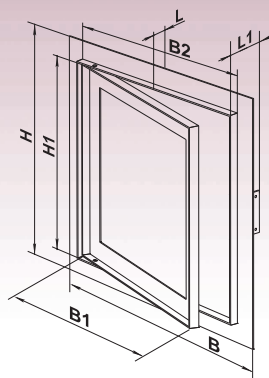

The special mechanism provides for secure locking

Application

- Designed for plasterboard walls and ceilings 12.5 and 15 mm thick.
- Enable quick and convenient access to concealed equipment and utility lines.
- Suitable for high-humidity areas.
- Protected by national patents worldwide.

Design

- The main structural frame and panel frame are made of aluminum profile.
- The special mechanism ensures secure locking, large-size doors are equipped with double locks.

- Left or right-side opening.
- Press gently to open and close.
- A wide range of sizes.
- Custom sizes are available upon request.

Mounting

- The doors are attached to aluminum profiles on self-tapping screws and flushed up with plasterboard on the front.
- Universal mountings for left or right-side opening.
- Easy servicing.

Sample Installations

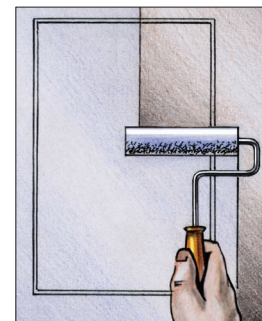
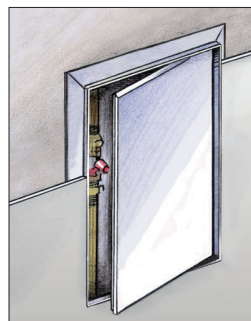

Dimensions

Model	Dimensions [mm]					
	H/B	H1/B1	B2	L	L1	Number of locks
DG 200x200	260	196	204	15	55	1
DG 300x300	360	296	304	15	55	1
DG 400x400	460	396	404	15	55	2
DG 500x500	560	496	504	15	55	2
DG 600x600	660	596	604	15	55	2

DPM series

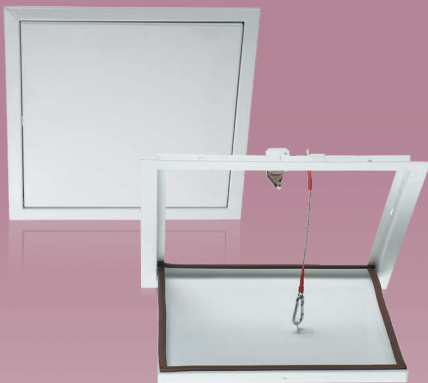

Access metal doors for ceiling mounting

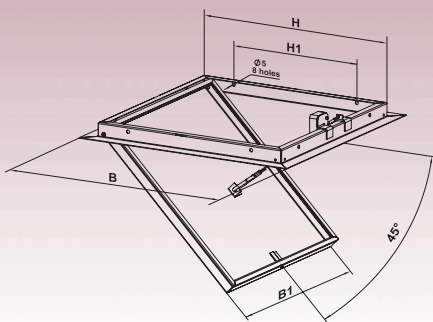

Application

- Designed for ceiling application.
- Enable quick and convenient access to concealed equipment and utility lines.
- Suitable for high-humidity areas.
- Protected by national patents worldwide.

Design

- Made of high-quality durable polymer-coated steel.
- The use of zinc phosphate compound ensures 100 % coating integrity and provides a reliable corrosion protection.
- Specially designed mechanical lock provides a safe door fixation.

- Easy opening and closing with a slight pressing.
- Custom sizes are available upon request.
- The doors are equipped with a galvanized steel safety rope with a snap hook to retain doors in a position that enables inspection works.
- The door opening angle with a safety rope is 45°.
- Open the snap hook if a wider opening angle is required for inspections.
- The doors are lined with a sealant for tight connection between the doors and the frame.

Mounting

- Screw fixation to the ceiling-mounted aluminium shape.



Dimensions

Model	Dimensions [mm]			
	□ B	□ B1	□ H	H1
DPM 300x300	336.5	296.5	298	200

ventilation systems

www.ventilation-system.com

ACCESS DOORS



VENTS reserves the rights to modify any of its products' features, designs, components and specifications at any time and without notice to maintain the development and quality of manufactured goods.

2020-11

