

## HEAT RECOVERY VENTILATION UNIT CFH

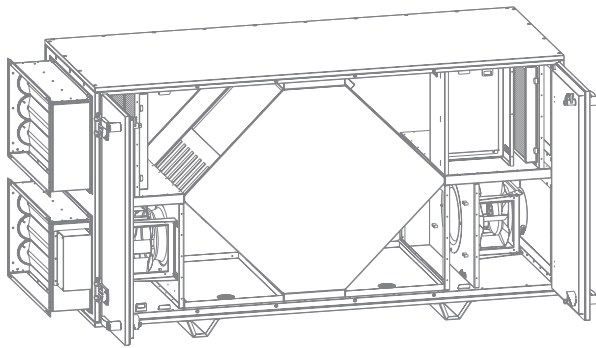

**AIRVENTS CFH, CFH-HE**

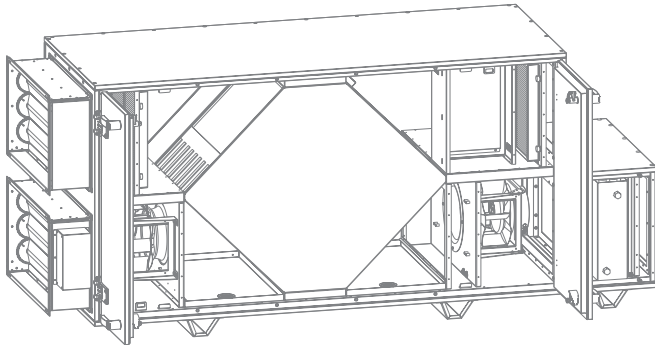

**AIRVENTS CFH-HW**

The brand new premium line of commercial heat recovery air handling units for floor mounting with high-efficient counter-flow heat exchanger. Available in five standard sizes based on the air flow capacity of 1500, 2500, 3500, 5000 and 6000 m<sup>3</sup>/h. Optionally accomplished with no heater (CFH series), electric heater (CFH-HE series) or water heater (CFH-HW series) and ready for operation with all necessary control elements.

### Main features:

- High-efficient EC fans, backward-curved, external rotor. Low power consumption at any speed, low noise level and stable operation in any climate conditions.
- Integrated plug-and-play controls on the basis of the Carel kVent. controller. Easy connecting via web-interface using the Ethernet-Modbus and BACnet.
- Insulated double-skin frameless casing.
- High-efficient counter-flow heat exchanger is made of profiled aluminium plates and impregnated with elastic heat-resistant sealant.
- The stainless steel drain pan is located on the inlet and outlet sides..
- The casing panels are made of steel with zinc-aluminium coating and internally lined with 40 mm heat- and sound-insulating mineral wool layer. The units have C4 corrosion resistance class in compliance with ISO 12944. Each model is available in left- and right-handed modifications. The units have service access on both sides and on the bottom.
- Washable F7, G4 (optional) panel filters in exhaust and supply air streams.
- Integrated control panels:
  - A30 th-Tune: standard control panel with handy interface ensures basic setup of parameters.
  - A32 pGDe: control panel with expanded functionality ensures complete setup of parameters.
- Integrated 100 % bypass of the heat exchanger with automatic damper and Belimo actuator ensures active freeze protection. Free heating and cooling functions are also available. Built-in automatic external air dampers with Belimo actuators.
- ECO-Design'18 compliant.

### Technical parameters

Model		CFH 1500	CFH 2500	CFH 3500	CFH 5000	CFH 6000
Nominal air flow [m <sup>3</sup> /h]		1500	2500	3500	5000	6000
EC fans	phase/voltage [50–60 Hz/VAC]	~1.200/277			~3.380/480	
	power/current [kW/A]	2x0.46/3.0	2x0.74/3.75	2x1.14/1.8	2x1.32/2.1	2x2.6/4.0
	fan speed [min <sup>-1</sup> ]	2848	2640	2400	1350	1700
	perm. amb. temp. [°C]	-35...+50				
	motor protection	IP54				
	insulation class	F				
	motor sound power level to outlet [dBA]	74	75	76	71	77.6
	SFP @ nominal air flow, max. pressure [kW/(m <sup>3</sup> /s)]	2x1.1	2x1.06	2x1.13	2x0.946	2x1.00
Filter class exhaust/supply standard (optional)	F7 (G4)/F7 (G4)					
Weight (net, without packaging) [kg]	270	310	360	570	620	
Protection class	IP34					
Sound pressure level @ 0.3 m to environment [dBA]	41	43	44	39	46	

# HEAT RECOVERY VENTILATION UNIT CFH, CFH-HE, CFH-HW

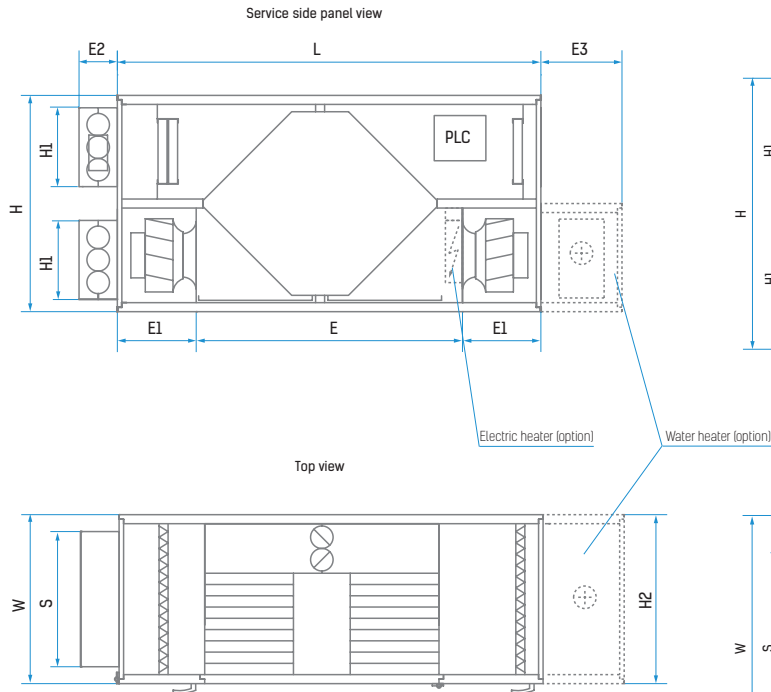
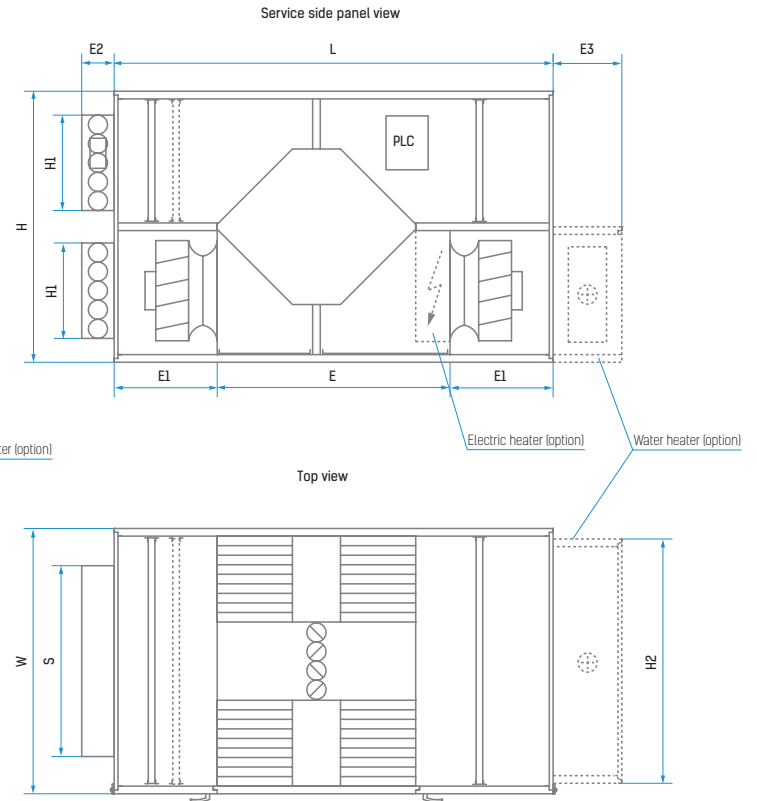
**CFH 1500, CFH 2000**

**CFH 3500, CFH 5000, CFH 6000**

Dimensions [mm]	CFH 1500	CFH 2500	CFH 3500	CFH 5000	CFH 6000
L	1880	1880	2200	2300	2300
W	750	750	890	1390	1390
H	960	960	1290	1420	1420
H1	350	350	350	500	500
H2 (optional)	750	750	890	1280	1280
S	600	600	600	1000	1000
E	1180	1180	1500	1220	1220
E1	350	350	350	540	540
E2	170	170	170	170	170
E3 (optional)	360	360	360	360	360

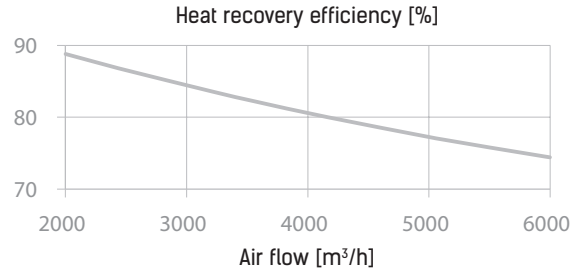
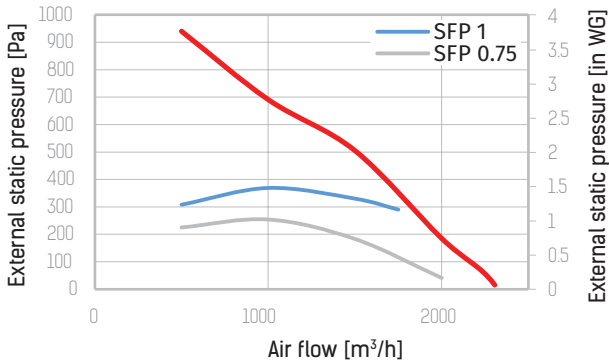
## CFH 1500



Sound power Lw in dB

Environment	66	65	62	52	33	53	48	51	59
Outlet	68	69	70	68	65	64	61	58	71
Hz	63	125	250	500	1000	2000	4000	8000	LwA

## CFH 2500

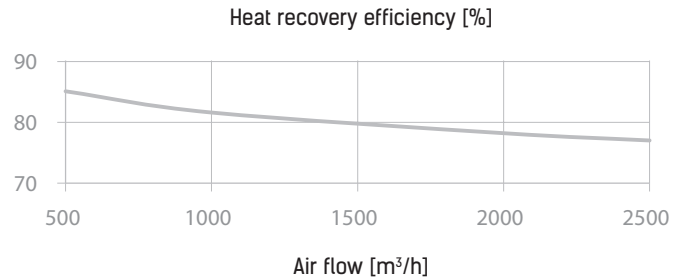
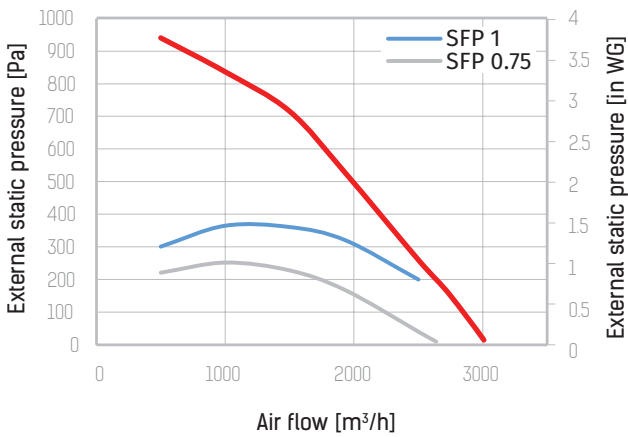

Sound power Lw in dB

Environment	63.6	65.5	64.2	58.2	40.1	57.2	52.2	55.4	63
Outlet	65.6	69.5	72.2	74.2	72.1	68.2	65.2	62.4	76.6
Hz	63	125	250	500	1000	2000	4000	8000	LwA

## CFH 3500

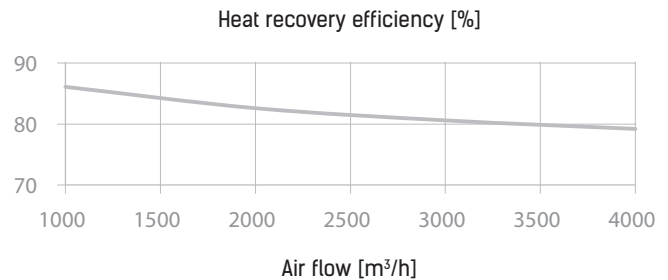
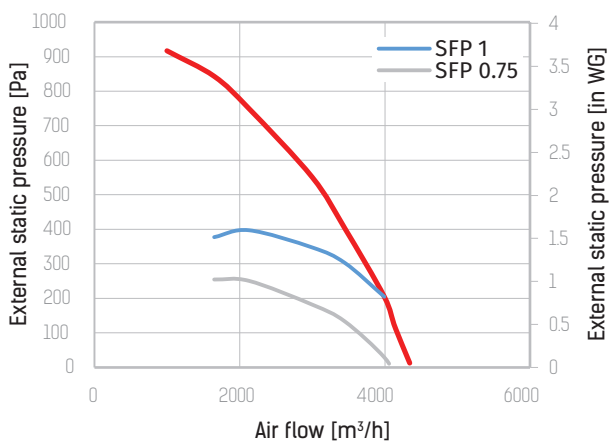

Sound power Lw in dB

Environment	67	64	66	57	37	59	53	57	64
Outlet	69	68	74	73	69	70	66	64	76
Hz	63	125	250	500	1000	2000	4000	8000	LwA

\*External SFP for each fan [kW/(m³/s)]

## CFH 5000

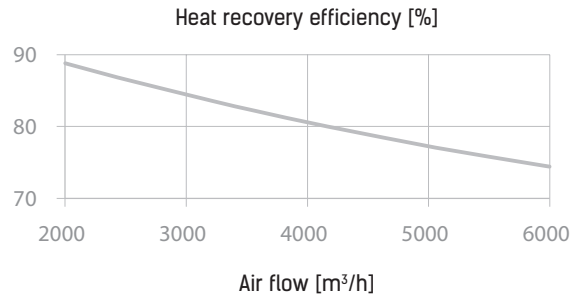
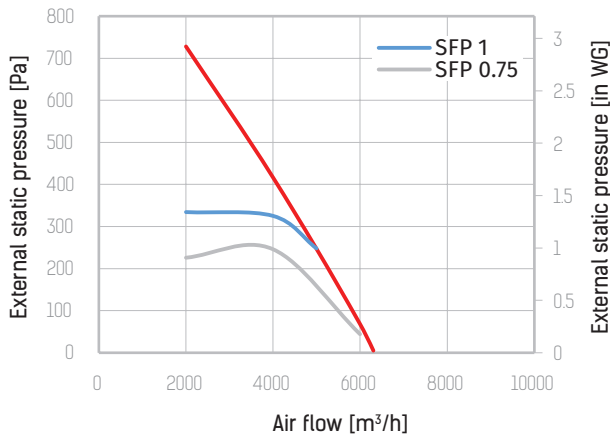

Sound power Lw in dB

Environment	66	65	62	52	33	53	48	51	59
Outlet	68	69	70	68	65	64	61	58	71
Hz	63	125	250	500	1000	2000	4000	8000	LwA

## CFH 6000

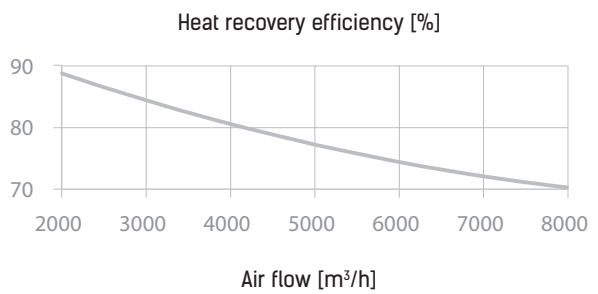
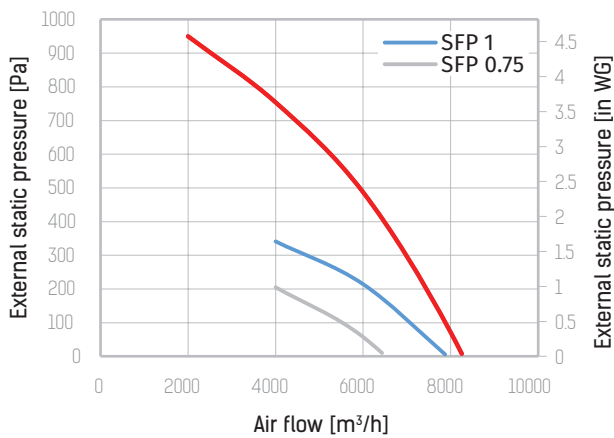

Sound power Lw in dB

Environment	66	65	62	52	33	53	48	51	59
Outlet	68	69	70	68	65	64	61	58	71
Hz	63	125	250	500	1000	2000	4000	8000	LwA

\*External SFP for each fan [kW/(m³/s)]