

Series

VENTS VUT/VUE HB EC
VENTS VUT/VUE HBE EC



Heat recovery air handling units in sound- and heat-insulated casings
Air flow up to **830 m³/h**
Heat recovery efficiency up to **98 %**

Description

The VUT/VUE HB EC and VUT/VUE HBE EC air handling units are the fully-featured ventilation units that ensure air filtration, fresh air supply and stale air extract. Used in ventilation and air conditioning systems in commercial, office and other public or industrial premises that require an economical solution and a controlled ventilation system.

Modifications

The **VUT HB EC** model is equipped with a counter-flow heat exchanger made of polystyrene. The **VUT HBE EC** model is equipped with a counter-flow heat exchanger made of polystyrene and an electric heater.

The **VUE HB EC** model is equipped with with an enthalpy counter-flow heat exchanger.

The **VUE HBE EC** model is equipped with an enthalpy counter-flow heat exchanger and an electric heater.

Casing

Made of aluzinc steel, internally filled with a 40 mm mineral wool heat- and sound-insulating layer.

Filter

Two built-in panel filters with filtration class G4 and F7 provide efficient supply air filtration. The G4 panel filter is used for extract air cleaning.

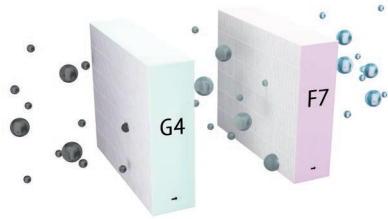

Fans

High-efficient electronically-commutated motors with external rotor. The 700 size units are equipped with fans with backward curved blades.

Heat exchanger

The VUT units are equipped with a counter-flow polystyrene heat exchanger.

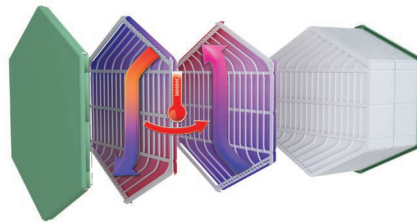

The VUE units are equipped with enthalpy counter-flow heat exchanger.

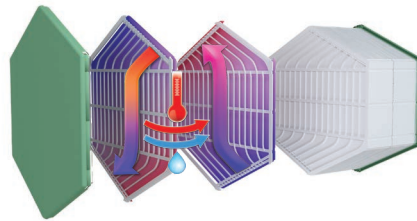

Heater

The **VUT/VUE HBE EC** units are equipped with an electric heater for additional heating of supply air downstream of the heat exchanger.

Bypass

The unit is equipped for summer cooling. If the unit is equipped with an electric heater, the bypass is used for freeze protection of the heat exchanger.

Automation

The **VUT/VUE HB(E) EC A21** units are equipped with an integrated control system. The A21 control-

ler allows integrating the unit into the Smart Home system or BMS (Building Management Systems). To control the unit using a mobile application via Wi-Fi, you need to download the VENTS Home mobile application.

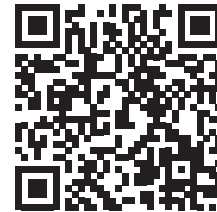

Google play

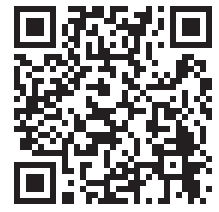

Download on the App Store



Freeze protection

Freeze protection in the **VUT/VUE HBE EC A21** units is achieved by a bypass. A preheater can be additionally installed in the **VUT/VUE HB EC A21** units for freeze protection.





Mounting

The unit is designed for suspended or floor mounting. Access for service and filter cleaning from the front panel. During mounting stage the front and the back panels can be reversed providing either left-handed or right-handed unit mounting.

Designation key

Series	Rated air flow [m³/h]	Spigot orientation	Bypass	Heater type	Motor type	Automation
VUT: ventilation with heat recovery VUE: ventilation with energy recovery	300; 400; 700	H: horizontal	B: bypass	_: without a heater E: electric heater	EC: synchronous electronically commutated motor	A21

Control and automation

Functions	A21
Control via Wi-Fi using a mobile application	+
Control via a wired remote control panel	option (A22) 
Wired remote LCD control panel	option (A25) 
Control via a wireless remote control panel	option (A22 Wi-Fi) 
BMS	RS-485 Wi-Fi Ethernet MODBUS (RTU, TCP)
Service Vents Cloud Server	+
Speed selection	+
Filter replacement indication	according to hour meter readings according to filter clogging differential pressure switch readings
Alarm indication	full alarm description in the mobile application
Week-scheduled operation	+
Bypass	automatic manual
Timers	+
Boost mode	+
Fireplace mode	+
Freeze protection	through cyclic stops of the supply fan through preheating (option) using a bypass
Reheater connection	option
Cooler connection	option
Minimum supply air temperature control	+
Humidity control	option
CO ₂ controller	option
VOC controller	option
PM2.5 control	option
Fire alarm sensor connection	option

*Option. The functionality is available when you purchase the appropriate accessory.

Overall dimensions

Model	Dimensions [mm]								
	Ø D	B	B1	B2	H	H1	H2	L	L1
VUT/VUE 300 HB(E) EC	157	566	190	189	479	193	118	1083	1180
VUT/VUE 400 HB(E) EC	197	682	248	217	504	201	141	1094	1191
VUT/VUE 700 HB(E) EC	247	866	274	296	601	234	166	1282	1379

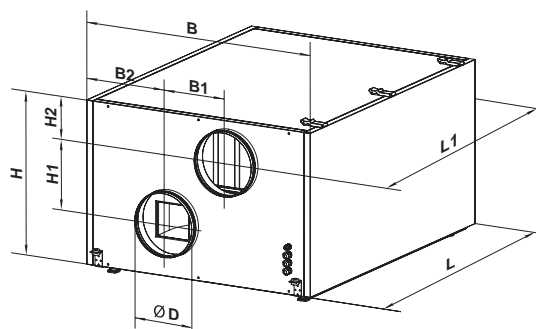

AIR HANDLING UNITS WITH HEAT RECOVERY

Technical data

	VUT 300 HB EC A21	VUT 300 HBE EC A21	VUE 300 HB EC A21	VUE 300 HBE EC A21
Unit voltage [V/50 (60) Hz]	1~230			
Maximum unit power (without a heater) [W]	182		182	
Maximum unit current (without a heater) [A]	1.4		1.4	
Electric heater power [W]	-	2800	-	2800
Electric heater current [A]	-	12.2	-	12.2
Maximum unit power with an electric heater [W]	182	2982	182	2982
Maximum unit current (with an electric heater) [A]	1.4	13.6	1.4	13.6
Maximum air flow [m ³ /h]	380		380	
RPM [min ⁻¹]	2100		2100	
Sound pressure level at 3 m distance [dBA]	24		24	
Maximum transported air temperature [°C]	-25...+40			
Casing material	galvanized steel			
Insulation	40 mm mineral wool			
Filter: extract	G4			
Filter: supply	G4+F7			
Connected air duct diameter [mm]	Ø160		Ø160	
Weight [kg]	63.1	64.3	63.1	64.3
Heat recovery efficiency	from 80 up to 98 %		from 74 up to 89 %	
Heat exchanger type	counter-flow			
Heat exchanger material	polystyrene		enthalpy	
SEC class	A+	A+	A	A

VENTS VUT/VUE HB(E) EC

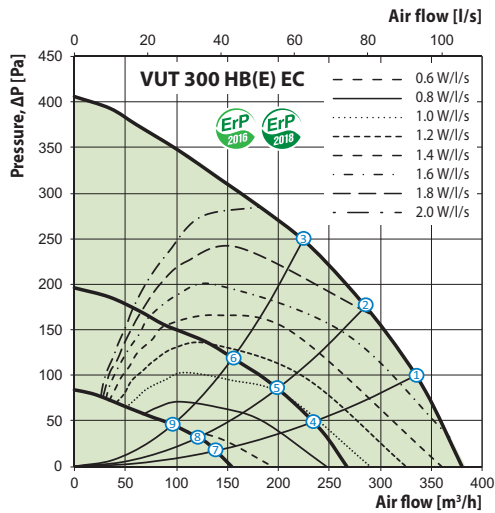

Point	Unit power (without a heater) [W]	Sound pressure level at 3 m (1 m) distance [dBA]
	VUT/VUE 300 HB(E) EC	VUT/VUE 300 HB(E) EC
1	155	24 (34)
2	143	23 (33)
3	119	23 (33)
4	61	20 (30)
5	56	20 (30)
6	46	20 (30)
7	20	13 (23)
8	19	13 (23)
9	18	13 (23)

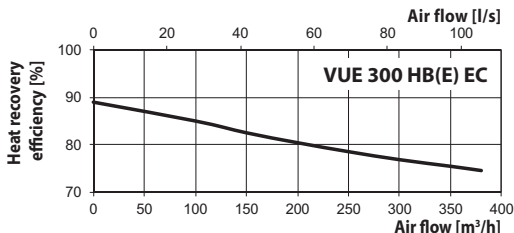
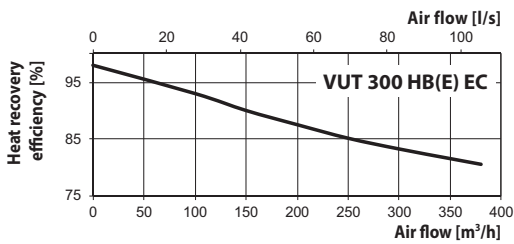

A-weighted sound power level	Gen. dBA	Octave-frequency band [Hz]								LpA, 3 m dBA	LpA, 1 m dBA	
		63	125	250	500	1000	2000	4000	8000			
L _{WA} to supply air inlet	dBA	67	50	55	56	62	60	62	56	50		
L _{WA} to supply air outlet	dBA	53	42	47	46	46	44	39	29	21		
L _{WA} to exhaust air inlet	dBA	68	56	54	61	62	59	61	56	50		
L _{WA} to exhaust air outlet	dBA	55	42	47	51	48	46	43	31	22		
L _{WA} surrounding	dBA	45	34	35	40	39	32	36	31	27	24	34

	VUT 400 HB EC A21	VUT 400 HBE EC A21	VUE 400 HB EC A21	VUE 400 HBE EC A21
Unit voltage [V/50 (60) Hz]	1~230			
Maximum unit power (without a heater) [W]	289		289	
Maximum unit current (without a heater) [A]	2.1		2.1	
Electric heater power [W]	-	2800	-	2800
Electric heater current [A]	-	12.2	-	12.2
Maximum unit power with an electric heater [W]	289	3089	289	3089
Maximum unit current (with an electric heater) [A]	2.1	14.3	2.1	14.3
Maximum air flow [m³/h]	540		540	
RPM [min⁻¹]	2600		2600	
Sound pressure level at 3 m distance [dBA]	27		27	
Maximum transported air temperature [°C]	-25...+40			
Casing material	galvanized steel			
Insulation	40 mm mineral wool			
Filter: extract	G4			
Filter: supply	G4+F7			
Connected air duct diameter [mm]	Ø200		Ø200	
Weight [kg]	74.8	76	74.8	76
Heat recovery efficiency	from 84 up to 98 %		from 78 up to 89 %	
Heat exchanger type	counter-flow			
Heat exchanger material	polystyrene		enthalpy	
SEC class	A+	A+	A	A

VENTS VUT/VUE HB(E) EC

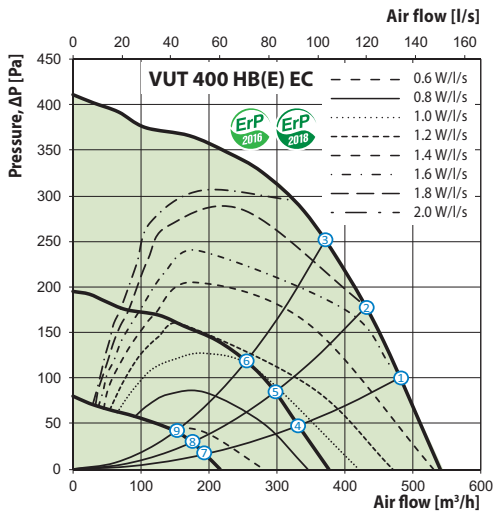

Point	Unit power (without a heater) [W]	Sound pressure level at 3 m (1 m) distance [dBA]
	VUT/VUE 400 HB(E) EC	VUT/VUE 400 HB(E) EC
1	240	27 (37)
2	215	26 (36)
3	196	26 (36)
4	89	21 (31)
5	80	21 (31)
6	72	20 (30)
7	27	19 (29)
8	26	19 (29)
9	24	17 (27)

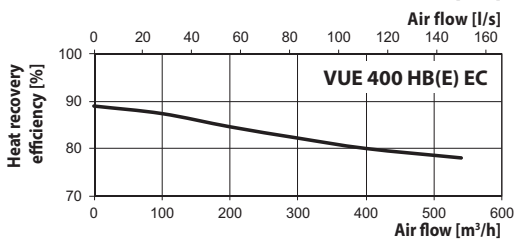
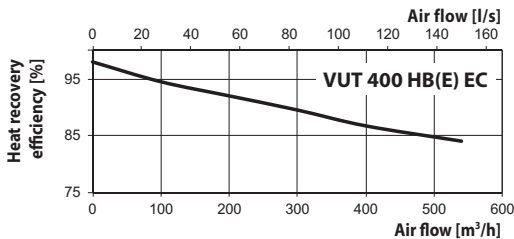

A-weighted sound power level	Gen. dBA	Octave-frequency band [Hz]							LpA, 3 m dBA	LpA, 1 m dBA		
		63	125	250	500	1000	2000	4000			8000	
L _{WA} to supply air inlet	dBA	71	52	57	57	68	64	64	59	53		
L _{WA} to supply air outlet	dBA	56	44	49	47	52	47	41	31	24		
L _{WA} to exhaust air inlet	dBA	70	52	56	60	66	62	64	60	53		
L _{WA} to exhaust air outlet	dBA	58	39	49	52	53	49	46	35	24		
L _{WA} surrounding	dBA	48	32	37	40	45	36	38	35	30	27	37

AIR HANDLING UNITS WITH HEAT RECOVERY

Technical data

	VUT 700 HB EC A21	VUT 700 HBE EC A21	VUE 700 HB EC A21	VUE 700 HBE EC A21
Unit voltage [V/50 (60) Hz]	1~230			
Maximum unit power (without a heater) [W]	336		336	
Maximum unit current (without a heater) [A]	2.4		2.4	
Electric heater power [W]	-	3600	-	3600
Electric heater current [A]	-	15.6	-	15.6
Maximum unit power with an electric heater [W]	336	3936	336	3936
Maximum unit current (with an electric heater) [A]	2.4	18.0	2.4	18.0
Maximum air flow [m³/h]	830		830	
RPM [min⁻¹]	3200		3200	
Sound pressure level at 3 m distance [dBA]	31		31	
Maximum transported air temperature [°C]	-25...+40			
Casing material	galvanized steel			
Insulation	40 mm mineral wool			
Filter: extract	G4			
Filter: supply	G4+F7			
Connected air duct diameter [mm]	Ø250		Ø250	
Weight [kg]	107	108.4	107	108.4
Heat recovery efficiency	from 80 up to 98 %		from 74 up to 89 %	
Heat exchanger type	counter-flow			
Heat exchanger material	polystyrene		enthalpy	
SEC class	A+	A+	A	A

VENTS VUT/VUE HB(E) EC

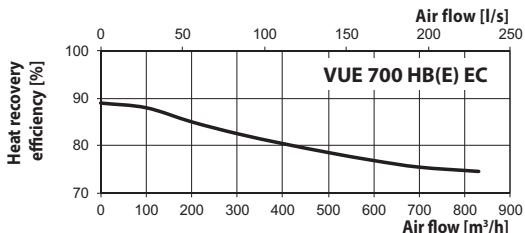
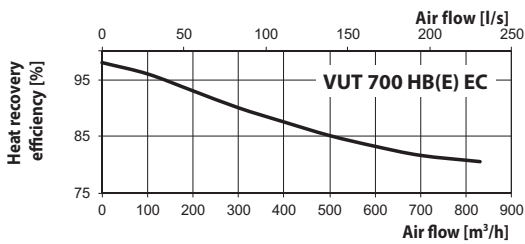
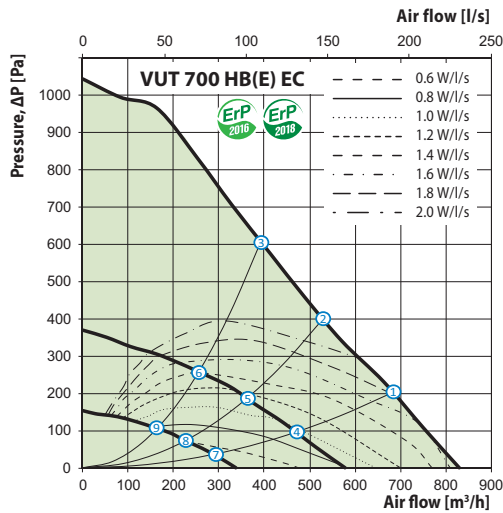

Point	Unit power (without a heater) [W]	Sound pressure level at 3 m (1 m) distance [dBA]
	VUT/VUE 700 HB(E) EC	VUT/VUE 700 HB(E) EC
1	336	31 (41)
2	336	30 (40)
3	336	29 (39)
4	123	25 (35)
5	115	25 (35)
6	96	24 (34)
7	41	23 (33)
8	38	23 (33)
9	36	20 (30)

A-weighted sound power level	Gen. dBA	Octave-frequency band [Hz]								LpA, 3 m dBA	LpA, 1 m dBA	
		63	125	250	500	1000	2000	4000	8000			
L _{WA} to supply air inlet	dBA	76	56	61	61	73	69	69	64	57		
L _{WA} to supply air outlet	dBA	60	49	53	52	56	51	44	34	26		
L _{WA} to exhaust air inlet	dBA	74	56	60	65	70	66	68	64	56		
L _{WA} to exhaust air outlet	dBA	61	42	53	56	56	52	49	37	25		
L _{WA} surrounding	dBA	51	35	40	43	49	39	40	37	32	31	41

Accessories for air handling units

Model	G4 panel filter	F7 panel filter	LCD control panel	Control panel	Wi-Fi controllable control	Humidity sensor (0-10 V)	CO ₂ sensor	CO ₂ sensor with indication	Humidity sensor	VOC sensor (0-10V)	CO ₂ sensor (0-10V)	Humidity sensor (0-10V)
VUT/VUE 300 HB EC A21	SF	SF	A25	A22	A22 Wi-Fi	HV2	CO2-1	CO2-2	HR-S	DPWQ 30600	DPWQ 40200	DPWC 11200
VUT/VUE 300 HBE EC A21	484x178x48 G4	484x178x48 F7								DPWQ 30600	DPWQ 40200	DPWC 11200
VUT/VUE 400 HB EC A21	SF	SF	A25	A22	A22 Wi-Fi	HV2	CO2-1	CO2-2	HR-S	DPWQ 30600	DPWQ 40200	DPWC 11200
VUT/VUE 400 HBE EC A21	600x205x48 G4	600x205x48 F7								DPWQ 30600	DPWQ 40200	DPWC 11200
VUT/VUE 700 HB EC A21	SF	SF	A25	A22	A22 Wi-Fi	HV2	CO2-1	CO2-2	HR-S	DPWQ 30600	DPWQ 40200	DPWC 11200
VUT/VUE 700 HBE EC A21	784x253x48 G4	784x253x48 F7								DPWQ 30600	DPWQ 40200	DPWC 11200

Model	Electric reheater	Electric heater for preheating	Silencers		Back valves	Air dampers	Clamps	Drain pump	Electric actuator	
VUT/VUE 300 HB EC A21	NKD 160	NKP 160	SR 160 600/900/1200	SRF 160 600/900/1200	KOM 160	KRV 160	C 160	DN-2	LF230	TF230
VUT/VUE 300 HBE EC A21	-	NKP 160								
VUT/VUE 400 HB EC A21	NKD 200	NKP 200	SR 200 600/900/1200	SRF 200 600/900/1200	KOM 200	KRV 200	C 200	DN-2	LF230	TF230
VUT/VUE 400 HBE EC A21	-	NKP 200								
VUT/VUE 700 HB EC A21	NKD 250	NKP 250	SR 250 600/900/1200	SRF 250 600/900/1200	KOM 250	KRV 250	C 250	DN-2	LF230	TF230
VUT/VUE 700 HBE EC A21	-	NKP 250								

Unit design

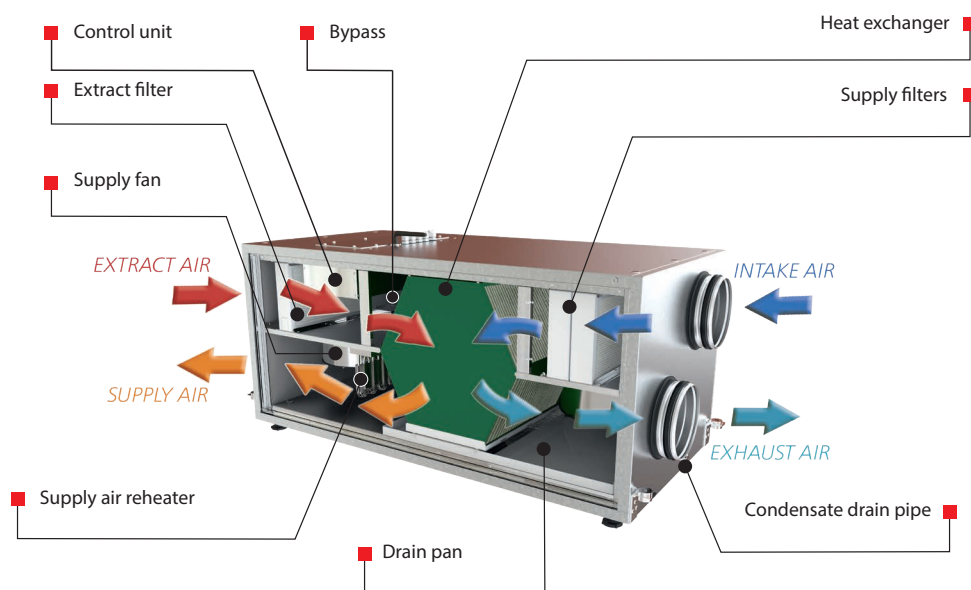

Application options

